

Constraining the properties of dense matter

William Lynch, Michigan State University

- A. What is the EOS? \Rightarrow
 - 1. Relationship to nuclear masses \Rightarrow
 - 2. Theoretical approaches \Rightarrow
 - 3. Example: T=0 with Skyrme \Rightarrow
 - 4. Relevance to astrophysics \Rightarrow
- B. What nuclear observables are sensitive to the symmetric matter EOS and at what densities? \Rightarrow
 - 1. Giant resonances \Rightarrow
 - 2. Particle flow and particle production \Rightarrow
 - 3. Resulting constraints \Rightarrow
- C. What nuclear observables are sensitive to the symmetry energy and at what densities? \Rightarrow
 - 1. Binding energies \Rightarrow
 - 2. Radii of neutron and proton matter in nuclei \Rightarrow
 - 3. “Pygmy” and Giant resonances $\Rightarrow\Rightarrow$
 - 4. Particle flow and particle production \Rightarrow
- D. Summary \Rightarrow

The EOS:

Finite temperature:

The EOS describes how the pressure P depends on the temperature T , the density ρ and the asymmetry $\delta = (\rho_n - \rho_p) / \rho$:

$$P = P(\rho, T, \delta)$$

Here, ρ designates the number density of nucleons ($\rho = 0.16$ nucleons/ fm³) for nuclear matter at saturation density.

One can use $\varepsilon = E/A$, the average energy per particle in the system, to calculate P:

$$P = P(\rho, T, \delta) = - \left. \frac{\partial F}{\partial V} \right|_{T, \delta} = \left. \frac{\rho^2 \partial f(\rho, T, \delta)}{\partial \rho} \right|_{T, \delta} \quad (1)$$

where $f(\rho, T, \delta) = F/A = \varepsilon(\rho, T, \delta) - T\sigma(\rho, T, \delta)$.

Here f is the Helmholtz free energy per nucleon, which can be obtained from the partition function and σ is the entropy per nucleon. σ can be obtained from:

$$\sigma = \int_0^T \frac{[\varepsilon_V]_{\delta}}{T} = \int_0^T \frac{c_V dT}{T},$$

where $c_V = \left. \frac{\partial \varepsilon}{\partial T} \right|_{V, \delta}$ is the heat capacity per nucleon (2)

Exercise 1: Obtain the approximate expression $\sigma(\rho, T, \delta) \approx \pi^2 T / (2 \varepsilon_F(\rho))$ for the fermionic nuclear system at density ρ , assuming all temperature dependence in ε resides in the nucleon kinetic energies. Assume for simplicity that $\rho_n = \rho_p$.

Zero temperature

If one is at low enough temperature, one can ignore the dependence of the EOS on temperature and evaluate the EOS at $T=0$. For $T=0$,

$$P = P(\rho, 0, \delta) = \left. \frac{\rho^2 \partial f(\rho, 0, \delta)}{\partial \rho} \right|_{T, \delta} = \left. \frac{\rho^2 \partial \varepsilon(\rho, 0, \delta)}{\partial \rho} \right|_{\sigma, \delta} \quad (3)$$

Phase transitions:

Phase transitions can manifest themselves in the EOS if there are regions where $dP/d\rho|_T < 0$, making the matter mechanically unstable. Where this occurs in simple systems, one must match the chemical potentials for the denser and more dilute phases by making a Maxwell construction, in which the area, $A = \int V dp$ between the Maxwell construction line and the original EOS is equal on the left and the right side.

The straight line shows an EOS (in red) and its Maxwell construction in blue. (In most places, the red and blue coincide and only the blue is visible. The red curve can only be seen in the unstable region.) Note, a system may follow the dashed curve for a while even in the mixed phase region if the expansion or compression is fast enough. This sometimes happens in a nuclear collision

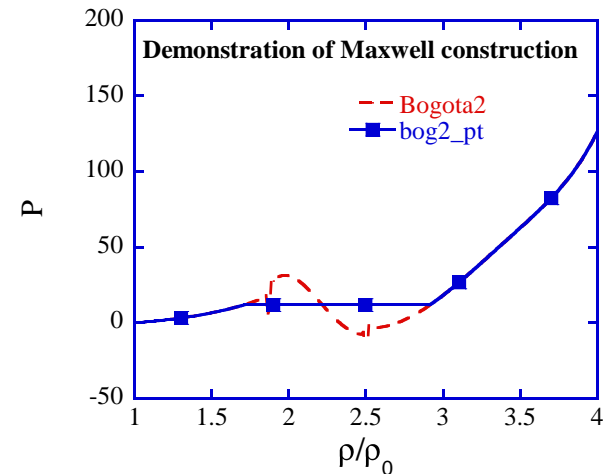

Phase equilibrium is generally considered in equilibrated systems at $\rho < 0.5\rho_0$ (L.G.P.T.) and at $\rho > 9\rho_0$ (Q.M.P.T.)

Nuclear masses and the EoS

$$M_{A,Z}c^2 = Zm_p c^2 + (A-Z)m_n c^2 - B_{A,Z}$$

$$B_{A,Z} = a_v[1-b_1((N-Z)/A)^2]A - a_s[1-b_2((N-Z)/A)^2]A^{2/3} - a_c Z^2/A^{1/3} + \delta_{A,Z}A^{-1/2} + C_d Z^2/A,$$

- Fits of the liquid drop binding energy formula experimental masses can provide values for a_v , a_s , a_c , b_1 , b_2 , C_d and $\delta_{A,Z}$.
- Relationship to EOS $\langle E/A \rangle = \varepsilon(\rho, 0, \delta) = \varepsilon(\rho, 0, 0) + S \delta^2; \delta = (n - \rho_p) / \rho$
 - $a_v \approx \varepsilon(\rho_s, 0, 0)$; $a_v b_1 \approx S(\rho_s)$
 - a_s and $a_s b_2$ provide information about the density dependence of $\varepsilon(\rho_s, 0, 0)$ and $S(\rho_s)$ at subsaturation densities $\rho \approx 1/2\rho_s$. (See Danielewicz, Nucl. Phys. A 727 (2003) 233.)
 - The various parameters are correlated. Coulomb and symmetry energy terms are strongly correlated. Shell effects make masses differ from LDM.
- Mass compilations exist: e.g. Audi et al, NPA 595, (1995) 409.
- Measurement techniques:
 - Penning traps: $\omega = qB/m$
 - Time of flight: $\text{TOF} = \text{distance}/v$ $B\rho = mv/q$
 - Transfer reactions: $A(b,c)D$ $Q = (m_A + m_b - m_c - m_D)c^2$

Theoretical approaches for calculating the EoS

- Variational and Brueckner model calculations with realistic two-body nucleon-nucleon interactions: (see Akmal et al., PRC 58, 1804 (1998) and refs therein.)
 - Variational minimizes $\langle H \rangle$ with elaborate ground state wavefunction that includes nucleon-nucleon correlations.
 - Incorporate three-body interactions (needed for saturation in NR treatments).
 - Some are "fundamental"
 - Others model relativistic effects.
- Relativistic mean field calculations using relativistic effective interactions, (see Lalasissis et al., PRC 55, 540 (1997))
 - Well defined transformations under Lorentz boosts (collisions)
 - Parameterization can be adjusted to incorporate new data.
- Skyrme parameterizations: (Vautherin and Brink, PRC 5, 626 (1972).)
 - Requires transformation to local rest frame (collisions)
 - Computationally straightforward - [example](#)

T=0 with Shyrme: What is a mean field potential?

Consider a system of N Fermions. The total energy is given by the Hamiltonian:

$$H = \sum_i t_i + \sum_{i<j} V_{ij} + \sum_{i<j<k} V_{ijk} + \dots \quad ; \quad t_i \equiv \frac{p_i^2}{2m}$$

Approximating the N Fermion wave function by a Slater determinant

$$|\psi\rangle = A \prod_{i=1}^N |\phi_i \bar{r}_i\rangle \equiv \frac{1}{\sqrt{N!}} \text{Det} |\phi_i \bar{r}_i|$$

the energy, $E = \langle \psi | H | \psi \rangle$, of a state $|\psi\rangle$ is obtained from expectation value of the Hamiltonian

Hartree “direct”

Fock “exchange”

$$E = \sum_i \langle \phi_i \bar{r}_i | t_i | \phi_i \bar{r}_i \rangle + \sum_{i<j} \langle \phi_i \bar{r}_i \phi_j \bar{r}_j | V_{ij} | \phi_i \bar{r}_i \phi_j \bar{r}_j \rangle - \langle \phi_i \bar{r}_i \phi_j \bar{r}_j | V_{ij} | \phi_i \bar{r}_j \phi_j \bar{r}_i \rangle + \dots (1).$$

- In the Hartree term, the particles remain in their original states.
- In the Fock term, the two particles swap states.

As an exercise you can show that a three body potential would have one direct term of the form $\sum_{i<j<k} \langle \phi_i \mathbf{r}_i \phi_j \mathbf{r}_j \phi_k \mathbf{r}_k | \mathbf{V}_{ijk} | \phi_i \mathbf{r}_i \phi_j \mathbf{r}_j \phi_k \mathbf{r}_k \rangle$ (2) and five exchange terms.

For a central two body force $V_{12} = V_{21} = V(|\mathbf{r}_1 - \mathbf{r}_2|)$, varying the single particle wave functions $|\phi_i\rangle$ to minimize the energy of the ground state provides the Hartree Fock equation:

$$-\frac{\hbar^2}{2m} \nabla_1^2 \phi_i(\mathbf{r}_1) + \left(\sum_j^{\text{occupied}} \int \phi_j^*(\mathbf{r}_2) V(|\mathbf{r}_1 - \mathbf{r}_2|) \phi_j(\mathbf{r}_2) d^3r_2 \right) \phi_i(\mathbf{r}_1) - \sum_j^{\text{occupied}} \int \phi_j^*(\mathbf{r}_2) V(|\mathbf{r}_1 - \mathbf{r}_2|) \phi_j(\mathbf{r}_1) \phi_i(\mathbf{r}_2) d^3r_2 = \epsilon_i \phi_i(\mathbf{r}_1)$$

Hartree "direct"
Fock "exchange"

The first (Hartree) mean field potential, can be simplified

$$U_H = \sum_{j \neq i}^{\text{occupied}} \int d^3r_2 \rho_j(\mathbf{r}_2) V(|\mathbf{r}_1 - \mathbf{r}_2|) \quad (3)$$

As an exercise you can show that for a Coulomb two body force, it gives the classical Coulomb mean field potential.

The second "exchange" term is nonlocal and generally smaller. In the following, we "rescale" U_H to be equal to $U_H + U_F$. Should also make it momentum dep.

Skyrme effective interactions

A variety of effective interactions can be employed in the Hartree Fock approach, but "free" nucleon-nucleon potentials do not lead to successful results because they are too repulsive at short range. Skyrme effective interactions are expressed in terms of delta functions and derivatives of delta functions [see Vautherin & Brink, PRC 5, 626 (1972).], and adjusted to reproduce nuclear properties. To illustrate some of their properties, consider a simple two parameter Skyrme interaction with a two body and a three body term of the

form:
$$V = a \sum_{i < j} \delta(\mathbf{r}_i - \mathbf{r}_j) + b \sum_{i < j < k} \delta(\mathbf{r}_i - \mathbf{r}_j) \delta(\mathbf{r}_j - \mathbf{r}_k)$$

Inserting the first term into Eq. 3:
$$U_H = \sum_{j \neq 1}^{\text{occupied}} \int d^3r_2 \rho_j(\mathbf{r}_2) V(|\mathbf{r}_1 - \mathbf{r}_2|) \approx a \sum_{j \neq 1}^{\text{occupied}} \rho_j(\mathbf{r}_1) \approx a\rho(\mathbf{r}_1)$$

Not surprisingly, the mean field for one particle is proportional to the density of the other. Similarly, the mean field for one particle coming from the three body term is proportional to the product of the densities for two other particles.

$$U_{3\text{-body}} \propto b \sum_{k \neq j \neq i}^{\text{occupied}} \rho_j(\mathbf{r}_i) \rho_k(\mathbf{r}_i) \propto b\rho^2(\mathbf{r}_i)$$

Additional 4 and 5 body terms would add cubic and quartic order density dependencies that could soften this quadratic dependence. Reflecting this, one sometimes softens this three body term by making its density dependence, ρ^σ , a free parameter; i.e. $U = a\rho + b\rho^\sigma$.

A simple EOS for asymmetric matter

We start with the corresponding mean field potential. For simplicity, we neglect exchange and assume a momentum independent Skyrme interaction. We use 4 parameters to fix a_v , $a_v b_1$, ρ_0 and K_V . For neutrons and protons, respectively, we have the following expressions for the respective mean fields:

$$U_n(\rho_n, \rho_p) = a\bar{\rho} + b\bar{\rho}^\sigma + c\bar{\rho}^{\gamma-1}(\rho_n - \rho_p)$$

and

$$U_p(\rho_n, \rho_p) = a\bar{\rho} + b\bar{\rho}^\sigma + c\bar{\rho}^{\gamma-1}(\rho_p - \rho_n)$$

where a is the coefficient for the attractive two-body interaction, b takes the short range repulsion and multi-nucleon diagrams into account, c describes the symmetry potential and

$$\bar{\rho} = \rho_n + \rho_p, \quad \bar{\rho} = \lambda\rho.$$

Calculating the potential energy:

When at this value of the mean field, increasing the neutron and proton densities by $d\rho_n$ and $d\rho_p$, increases the potential energy per unit volume by:

$$d(\rho_n \langle V_n \rangle + \rho_p \langle V_p \rangle) = U_n(\rho_n, \rho_p) d\rho_n + U_p(\rho_n, \rho_p) d\rho_p.$$

Exercise 2: Show the potential energy per unit volume is:

$$\rho_n \langle V_n \rangle + \rho_p \langle V_p \rangle = a \frac{\rho^2}{2} + b \frac{\rho^{\sigma+1}}{\sigma+1} + c \frac{\rho^{\gamma+1}}{\gamma+1} \left(\frac{\rho_n - \rho_p}{\rho} \right)^2.$$

- Hint: use the expressions for the differential increases in potential energy per unit volume above and do a parametric integration over λ from zero to one.

Dividing by the density, one obtains the average potential energy per nucleon:

$$\langle V \rangle = a \frac{\rho}{2} + b \frac{\rho^\sigma}{\sigma + 1} + c \frac{\rho^\gamma}{\gamma + 1} \delta^2, \text{ where } \delta = \frac{\rho_n - \rho_p}{\rho}.$$

To this, one must add the average kinetic energy, which we evaluate in the Thomas-Fermi approximation. At zero temperature it has the form:

$$\langle KE \rangle = \frac{\frac{3}{5} \varepsilon_f(\rho_n) \rho_n + \frac{3}{5} \varepsilon_f(\rho_p) \rho_p}{\rho} \approx \frac{3}{5} \varepsilon_f(\rho) + \frac{1}{3} \varepsilon_f(\rho) \delta^2$$

where $\varepsilon_f(\rho)$ is the Fermi kinetic energy at density ρ .

Putting the kinetic and potential terms together, one obtains an expression of the form:

$$\langle E/A \rangle \equiv \varepsilon(\rho, 0, 0) + S(\rho) \left(\frac{\sigma}{\sigma_0} \right)^2$$

where

$$\varepsilon(\rho, 0, 0) = \frac{3}{5} \varepsilon_f(\rho) + a \frac{\rho}{2} + b \frac{\rho^\sigma}{\sigma + 1}$$

and

$$S(\rho) = \frac{1}{3} \varepsilon_f(\rho) + c \frac{\rho^\gamma}{\gamma + 1}.$$

Choosing $a\rho_0 = -356$ MeV, $b\rho_0^\sigma = 303$ MeV, $\sigma = 1.17$ and

$c \frac{\rho_0^\gamma}{\gamma + 1} = 18$ MeV, provides a mean field with a bulk binding

energy of 16 MeV and a reasonable value for the symmetry energy at normal density. This choice of σ gives a “soft” nuclear incompressibility constant of $K_{nm} = 200$ MeV.

The average energy for symmetric matter, with $\delta=0$, and neutron matter, with $\delta=1$, and symmetry energy for this expression are shown in the figure below.

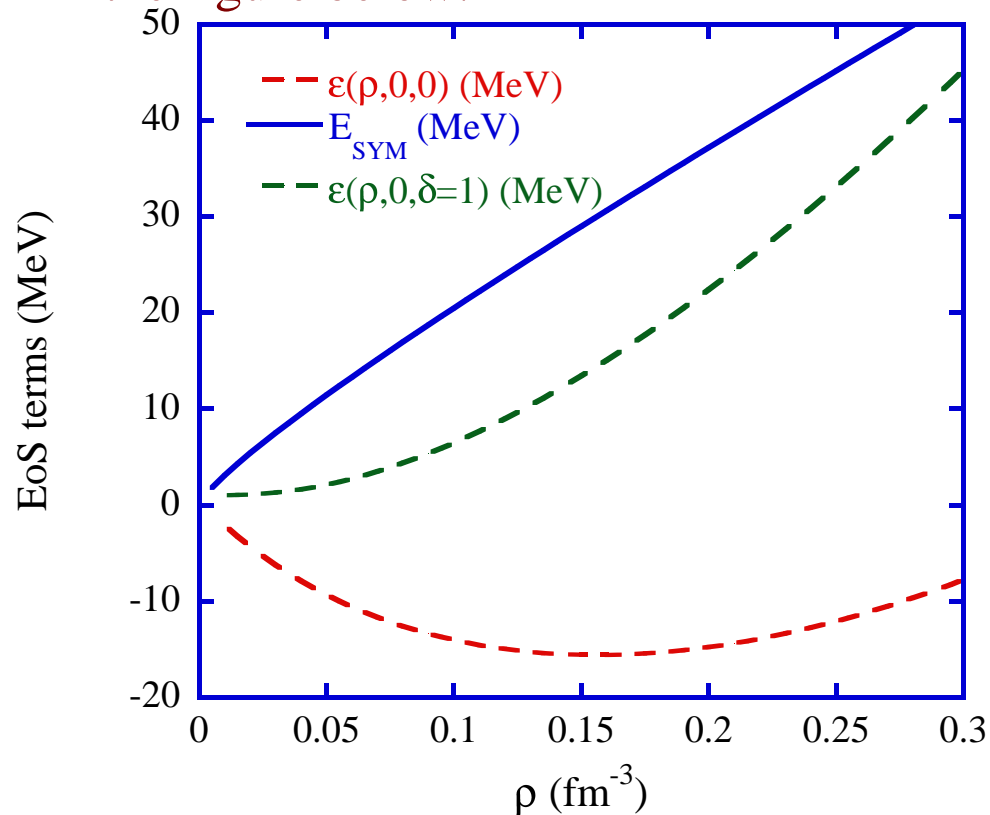

- Unlike symmetric matter, the potential energy of neutron matter is expected to be repulsive.
 - question: Where is pressure for symmetric matter and neutron matter positive? Where are they negative?

The EoS and Type II supernova: (collapse of 20 solar mass stars)

- Supernovae scenario: (Bethe Reference)
 - Nuclei $H \Rightarrow He \Rightarrow C \Rightarrow \dots \Rightarrow Si \Rightarrow Fe$
 - Fe stable, Fe shell cools and the star collapses
 - Matter compresses to $\rho > 4\rho_s$ and then expands
- Relevant densities and matter properties where the EOS plays a role
 - Compressed matter inside shock radius $\rho_0 < \rho < 10\rho_0$, $\delta \approx 0.2-0.9$
 - What densities are achieved?
 - What is the stored energy in the shock?
 - What is the neutrino emission from the proto-neutron star?
 - Clustered matter outside shock radius – mixed phase of nucleons and nuclear drops - nuclei: $\rho < \rho_0$, $\delta \approx 0.3-0.5$
 - How much energy is dissipated in vaporizing the drops during the explosion?
 - What is the nature of the matter that interacts and traps the neutrinos?
 - What are the seed nuclei that are present at the beginning of r-process which makes roughly half of the elements?
- Supernova calculations require $\epsilon(\rho, T, \delta)$ at all values of ρ , T, δ

Summary of last lecture

- The EOS describes the macroscopic response of nuclear matter and finite nuclei.

$$\varepsilon(\rho, 0, \delta) = \varepsilon(\rho, 0, 0) + \delta^2 \cdot S(\rho) ; \quad \delta = (\rho_n - \rho_p) / (\rho_n + \rho_p) = (N - Z) / A$$

- It can be calculated by various techniques. Skyrme parameterizations are a relatively easy and flexible way to do so. .
- The high density behavior and the behavior at large isospin asymmetries of the EOS are not well constrained.
- The behavior at large isospin asymmetries is described by the symmetry energy.
 - The symmetry energy has a profound influence on neutron star properties: stellar radii, maximum masses, cooling of proto-neutron stars, phases in the stellar interior, etc.

EOS, Symmetry Energy and Neutron Stars

The EOS influences:

- Neutron star stability against gravitational collapse
 - Stellar density profile
 - Internal structure: occurrence of various phases.
 - Observational consequences:
 - Cooling rates of proto-neutron stars
 - Cooling rates for X-ray bursters.
 - **Stellar masses, radii and moments of inertia.**
 - Frequencies of crustal vibrations.
- (mainly the symmetry energy)

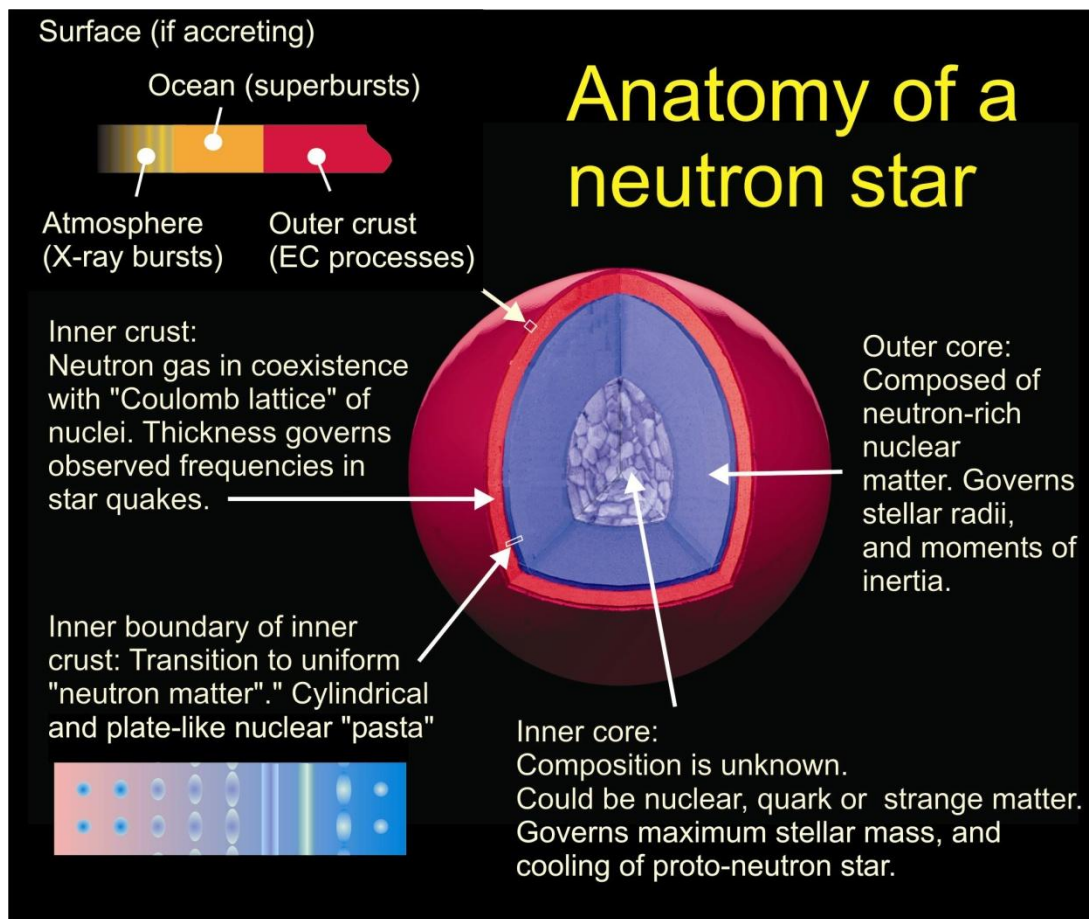

Strong motivation for "International X-ray Observatory"

- Cost ~ \$2B RY: Possible launch date 2020.

Sensitivity of the radius to the EoS

Basic Approach:

- Radius is obtained by inverting and integrating the Tolman-Oppenheimer-Volkov Equation.
- P is the pressure, which depends on the EoS and Symmetry energy.
- Need to take electrons and beta-equilibrium into account

$$\frac{dP}{dr} = -\frac{G}{r^2} \left[\rho r + \frac{P r}{c^2} \right] \left[\frac{M r + 4\pi r^3 \frac{P r}{c^2}}{1 - \frac{2GM r}{c^2 r}} \right]$$

$$P(\rho, \delta) = P_{\text{had}} + P_{\text{el}}; P_{\text{had}, T=0} \approx \rho^2 \left. \frac{\partial E/A}{\partial \rho} \right|_{s/a}$$

$$E/A(\rho, \delta) = E/A(\rho, 0) + \delta^2 \cdot S(r)$$

Neutron star radii :

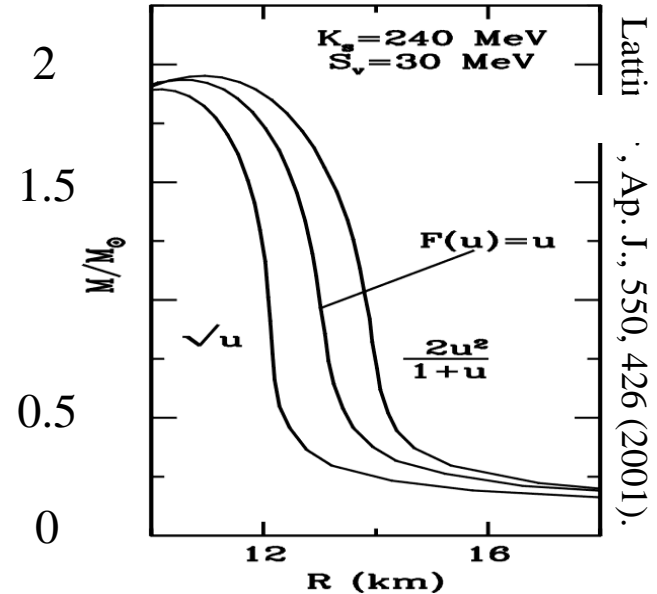

$$S_{\text{pot}}(\rho) = \text{const.} \cdot F(u); u = \rho / \rho_0$$

- These equations of state differ only in their density dependent symmetry terms.
- Idea is to measure the radii of neutron stars of different masses and constrain the EOS (integral constraint)

Connection between radius and EoS at specific density

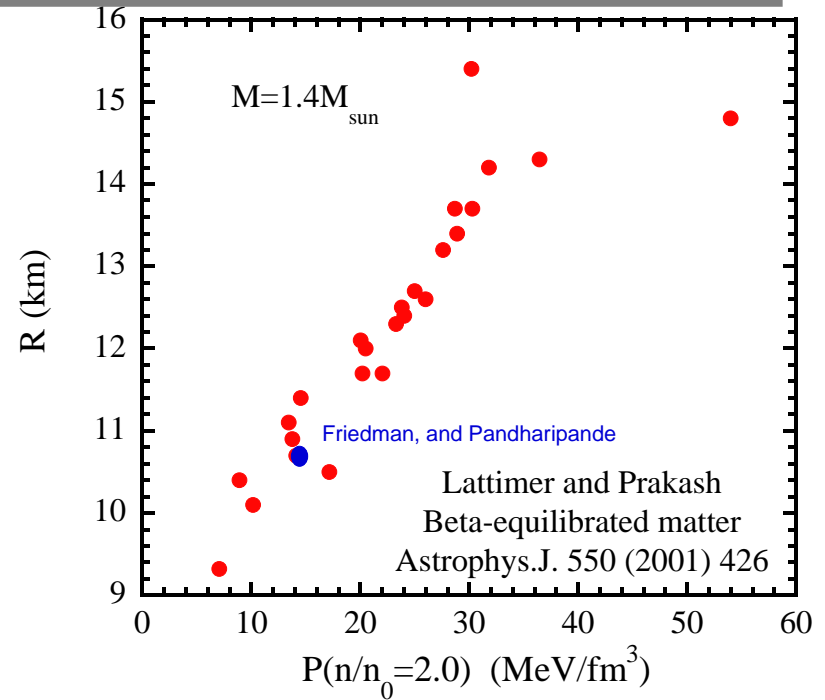
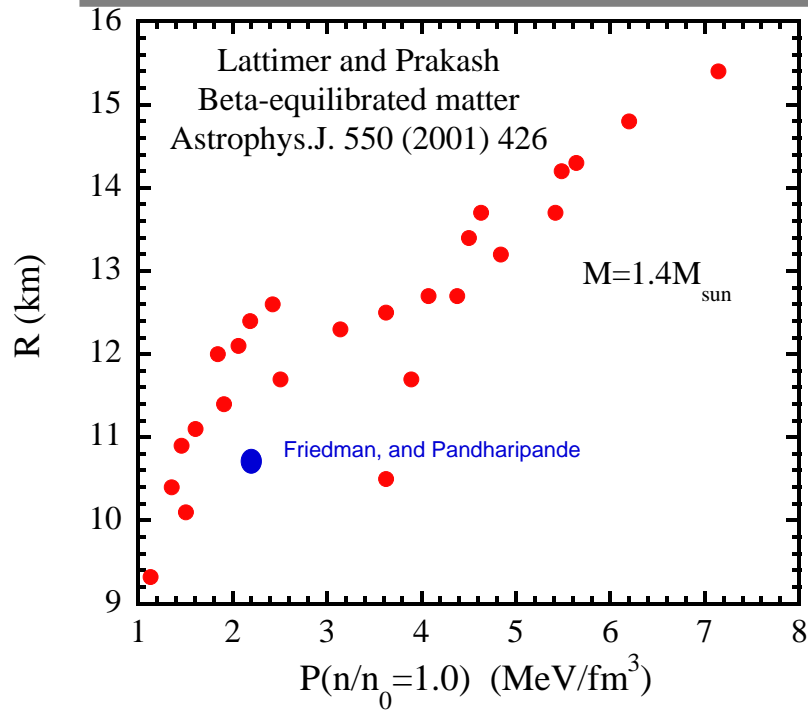

- The stellar radius is given by an integral involving the EoS over the stellar volume:
 - The neutron star radius is only weakly correlated with the symmetry pressure at saturation density.
 - There is a stronger correlation between neutron star radii and the pressure at twice saturation density.
 - It is important to measure observables that selectively probe specific densities,

Previous attempt: X-ray bursters

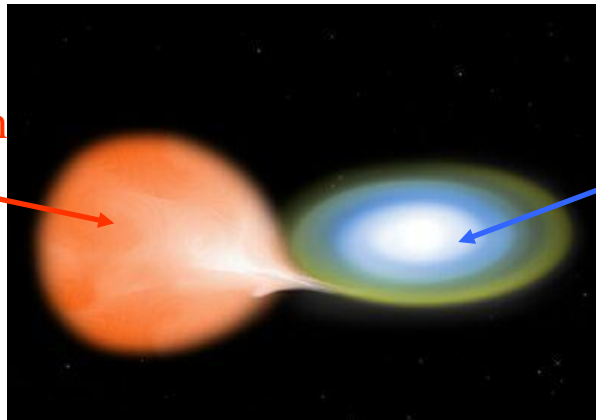

Companion star

neutron star

- EXO 0748 – 676 is a neutron star in a Binary system, which emits bursts of X-rays.
- Recent X-ray observations with XMM-Newton have identified red-shifted lines of O and Fe.
 - red shift $\Rightarrow M/R$ stellar distance
- Other assumptions:
 - Eddington flux: $F_{\text{edd}}(M, D, R)$
 - F_{cool}/T_c^4 : function of (R, M, D)

F. Ozel, Nature **441**, 1115 (2006).

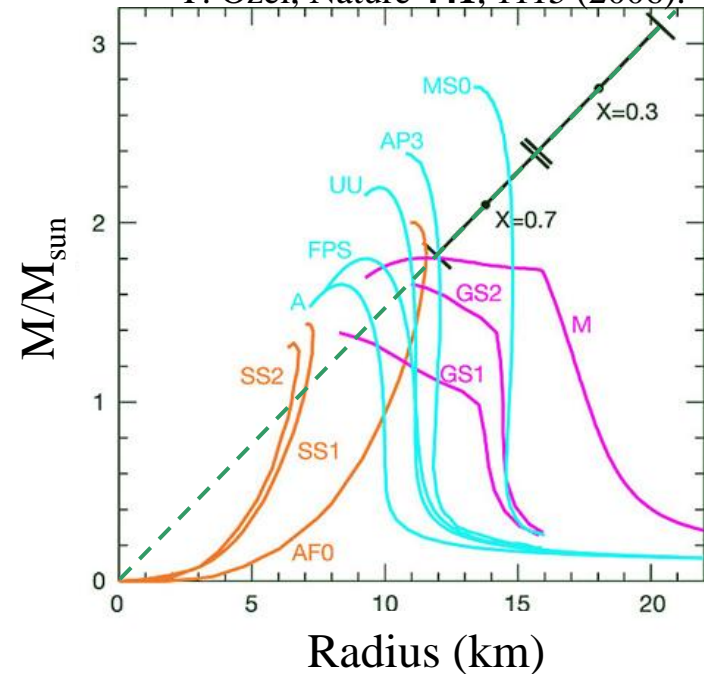

- Rules out most EOS's
 - "...If this object is typical, then condensates² and unconfined quarks¹ do not exist in the centres of neutron stars." Feryal Ozel, Nature **441**, 1115 (2006).

- The X-ray measurements and conclusions have not been confirmed.

Reanalysis of X-ray bursters data...

F. Ozel, ApJ. 693:1775, (2009).

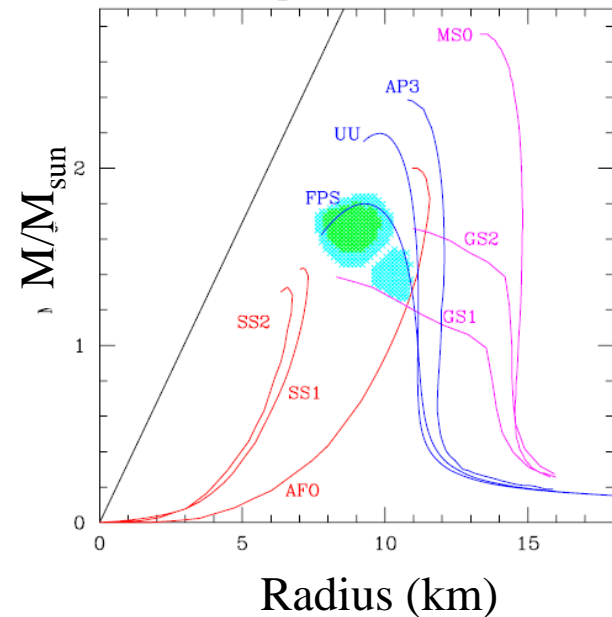
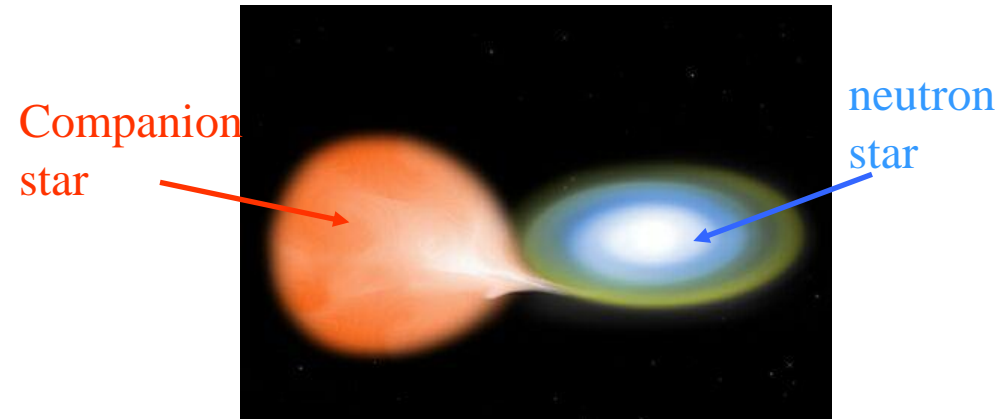

- Figure on the right one assumes the thickness of the atmosphere on the star EXO 1745-248 is relatively small: i.e. $R_{\text{ps}}=R$.
 - R_{ps} =photosphere radius
 - R =neutron star radius
- D is known.
- Assume Eddington luminosity.
- Measure distance plus:
 - Eddington flux: $F_{\text{edd}}(M, D, R)$
 - F_{cool}/T_c^4 : function of (R, M, D)
- Combine to get M, R

- Shaded region: deduced R, M
- Results consistent with a relatively soft equation of state.
- Similar, but somewhat more sophisticated analyses can be found in A. Steiner et al, arXiv:1005.0811
- Independent constraints from Laboratory measurements would be useful.

EoS: What are the questions?

$$B_{A,Z} = a_v [1 - b_1 ((N-Z)/A)^2] A - a_s [1 - b_2 ((N-Z)/A)^2] A^{2/3} - a_c Z^2/A^{1/3} + \delta_{A,Z} A^{-1/2} + C_d Z^2/A,$$

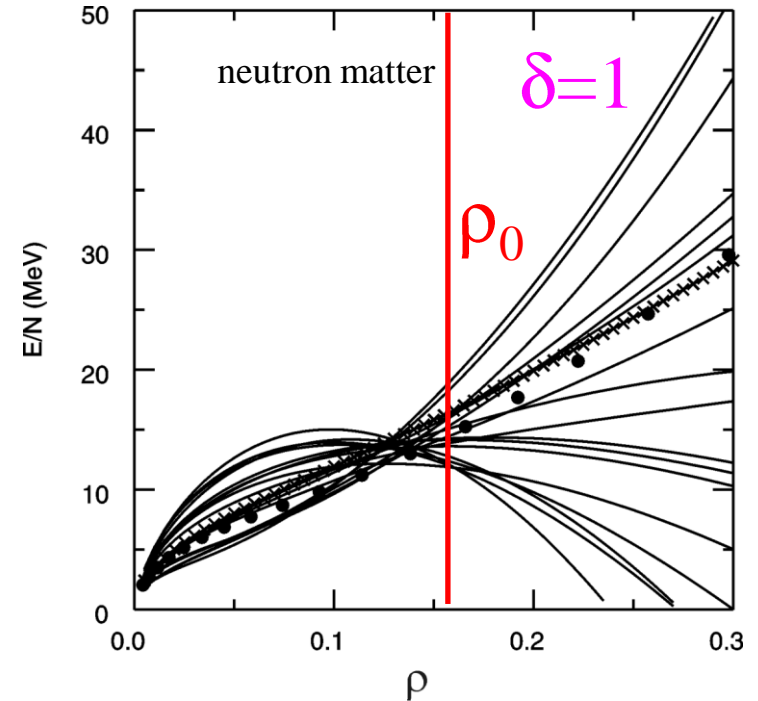
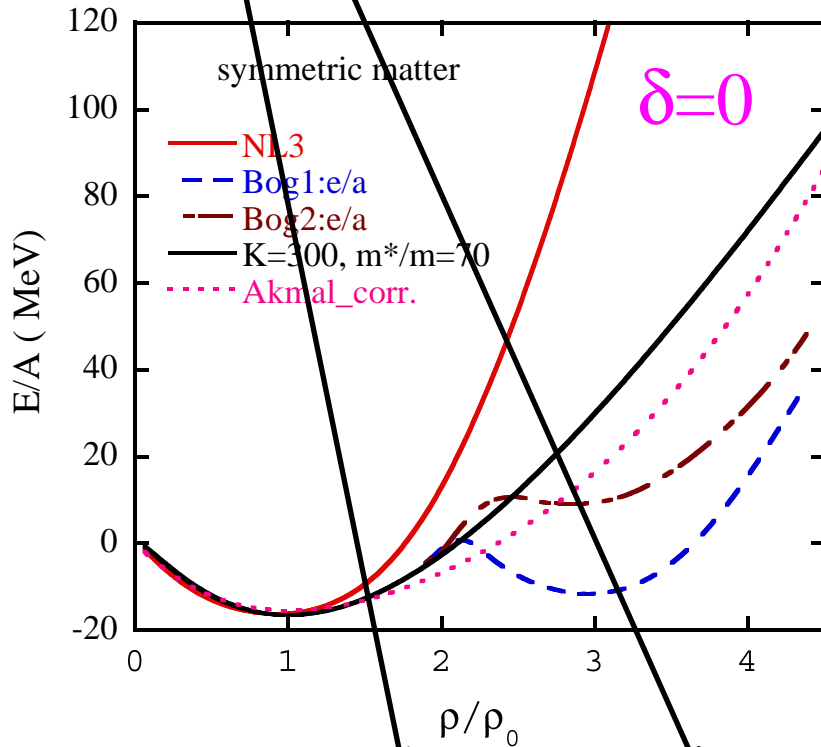

Brown, Phys. Rev. Lett. 85, 5296 (2001)

O

$$E/A(\rho, \delta) = E/A(\rho, 0) + \delta^2 S(\rho)$$

$$\delta = (\rho_n - \rho_p) / (\rho_n + \rho_p) = (N-Z)/A$$

$$P = \rho^2 \left. \frac{\partial (E/A)}{\partial \rho} \right|_{s/a}$$

- Nuclear effective interactions do not constrain neutron matter,
- Main uncertainty is the density dependence of the symmetry energy

Giant resonances

- Imagine a macroscopic, i.e. classical vibration of the matter in the nucleus.
 - e.g. Isoscaler Giant Monopole (GMR) resonance
- GMR and also ISGDR provide information about the curvature of $\epsilon(\rho,0,0)$ about minimum.

$$\epsilon(\rho,0,0) \approx -16\text{MeV} + \frac{1}{2} \frac{\partial^2 \epsilon}{\partial \rho^2} (\rho - \rho_s)^2$$
- Inelastic α particle scattering e.g. $^{90}\text{Zr}(\alpha, \alpha') ^{90}\text{Zr}^*$ can excite the GMR. (see Youngblood et al., PRL 92, 691 (1999).)
 - Peak is strongest at 0°

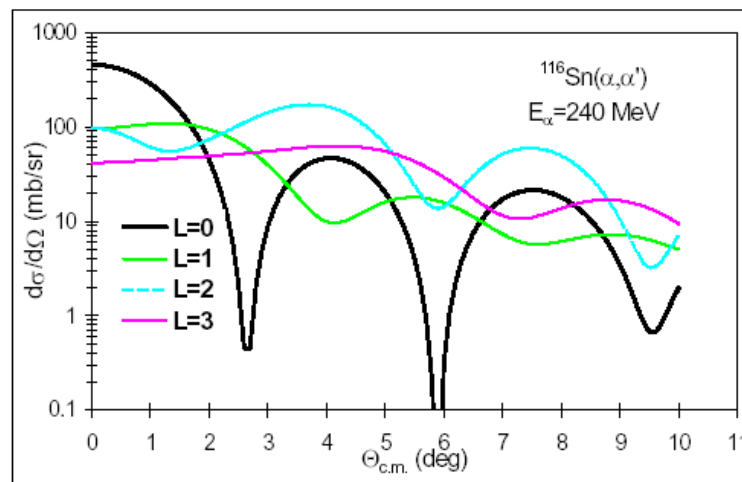
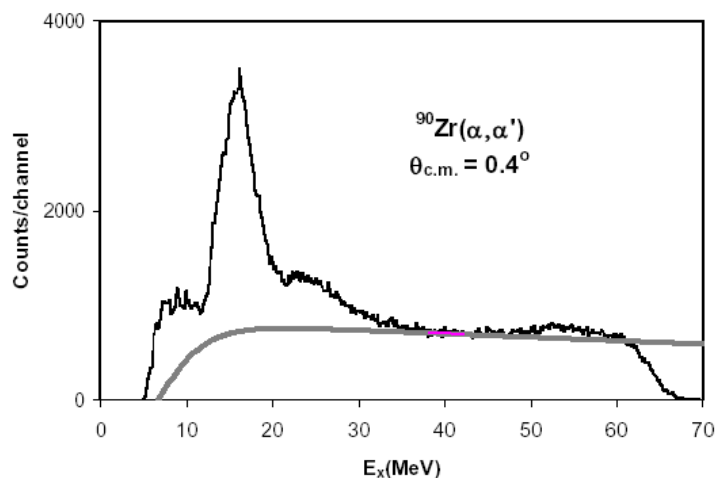
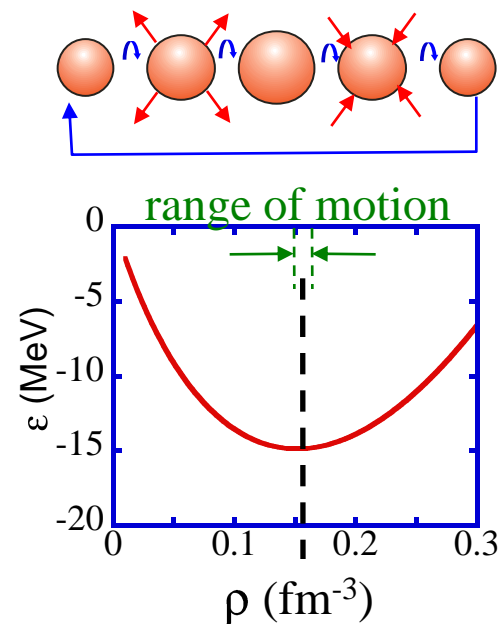

Giant resonances 1

- Exercise: Assume that we can approximate a nucleus as having a sharp surface at radius R and ignore the surface, Coulomb and symmetry energy contributions to the nuclear energy.

– In the adiabatic approximation show that $PE = A \varepsilon \left(\rho_s \left[\frac{R_0}{R} \right]^3, 0, 0 \right)$

– Show that $KE = 1/2 (5/3) MR^2 \dot{R}^2$

– Show that $E_{\text{GMR}} = \hbar \sqrt{\frac{K_{\text{nm}}}{m \langle r^2 \rangle}}$; where $K_{\text{nm}} \equiv \left. \frac{9\rho_s^2 \partial^2 \varepsilon}{\partial \rho^2} \right|_{\rho=\rho_s}$

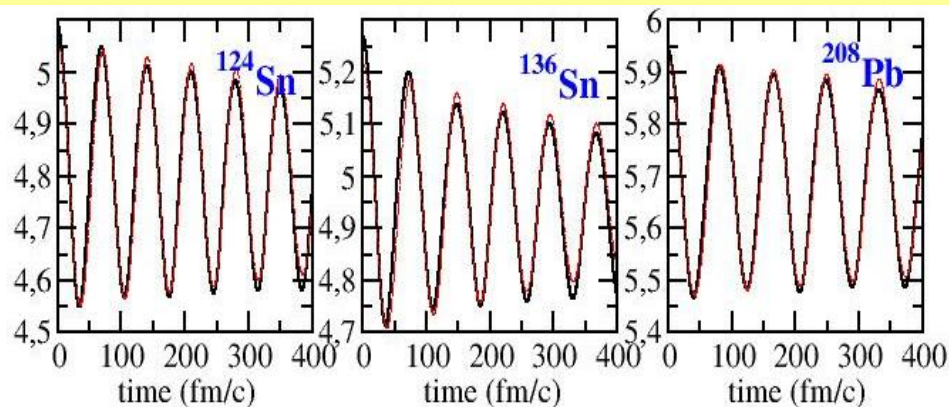

Vlasov calculations:
Gaitanos et al.,

Giant resonances 2

- Of course, nuclei have surfaces, etc. This motivates a "leptodermous" expansion (see Harakeh and van der Woude, "Giant Resonances" Oxford Science...):

$$E_{\text{GMR}} = \hbar \sqrt{\frac{K_A}{m \langle r^2 \rangle}}, \text{ where}$$

$$K_A = K_{\text{nm}} + K_{\text{surf}} A^{-1/3} + K_{\text{sym}} \cdot \delta^2 + K_{\text{Coul}} \cdot Z^2 / A^{4/3}$$

- K_{sym} is a function of the first and second derivatives of the symmetry energy (G. Colo, *et al.*, Phys. Rev. C70, 024307 (2004).)

$$K_{\text{sym}} = 9\rho_0^2 \left. \frac{\partial^2 S}{\partial \rho^2} \right|_{\sigma, \delta} + 9\rho_0 \left. \frac{\partial S}{\partial \rho} \right|_{\sigma, \delta} - \frac{81\rho_0^3}{K_V} \left. \frac{\partial S}{\partial \rho} \right|_{\sigma, \delta} \left. \frac{\partial^3 \rho \epsilon}{\partial \rho^3} \right|_{\sigma, \delta}$$

- Measurements of GMR resonance energies over a range of isotopes may provide information the first and second derivatives of the symmetry energy as a function of density! (Actually, the first derivative is more important)

Constraints on the symmetric matter EoS from laboratory measurements

- The symmetric matter EoS strongly limits what you probe with nuclei
 - If the EoS is expanded in a Taylor series about ρ_0 , K_{nm} provides the term proportional to $(\rho - \rho_0)^2$. GMR analyses indicate $K_{\text{nm}} = 240 \pm 10$ MeV. Higher order terms influence the EoS at sub-saturation and supra-saturation densities.
 - The solid black, dashed brown and dashed blue EoS's all have $K_{\text{nm}} = 300$ MeV → differences between these EoS's reflect these higher order terms.

- Nuclear properties are mainly sensitive to the EoS at $0.5\rho_0 \leq \rho \leq 1/25\rho_0$

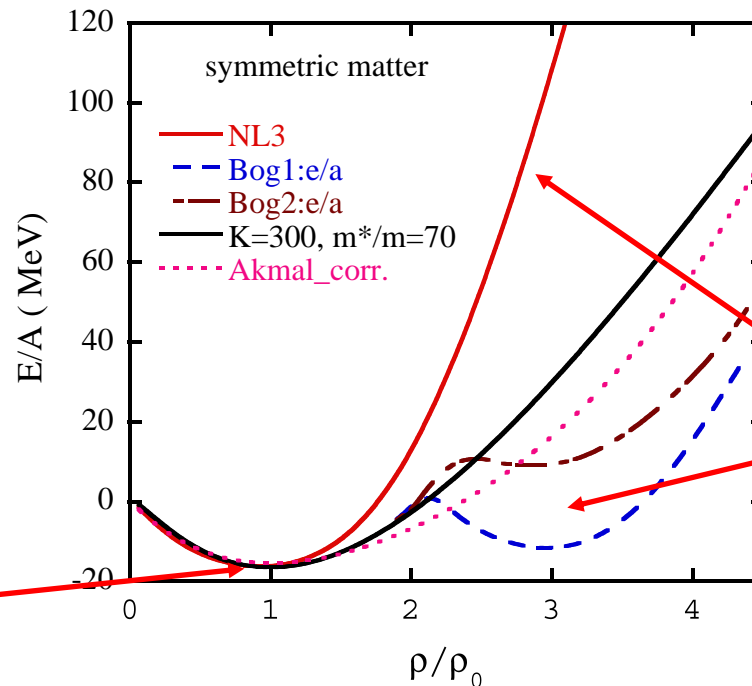

- To probe the EoS at $3\rho_0$, you need to compress matter to $3\rho_0$.

Constraining the EOS at high densities by laboratory collisions

Au+Au collisions $E/A = 1$ GeV

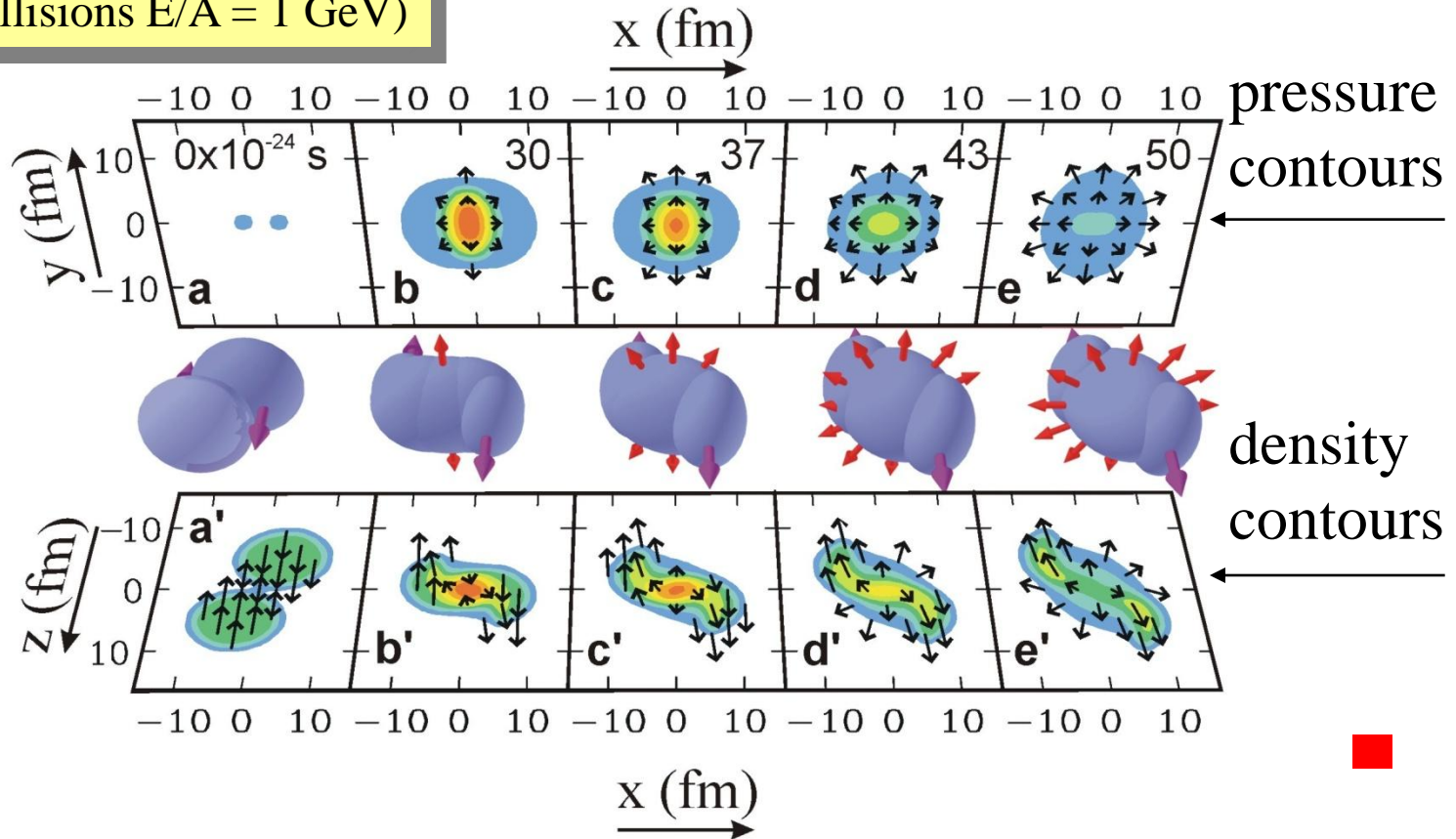

- Two observable consequences of the high pressures that are formed:
 - Nucleons deflected sideways in the reaction plane.
 - Nucleons are “squeezed out” above and below the reaction plane. .

Flow studies of the symmetric matter EOS

- Theoretical tool: transport theory:

- Example Boltzmann-Uehling-Uhlenbeck eq. (Bertsch Phys. Rep. 160, 189 (1988).) has derivation from Time Dependent Hartree Fock (TDHF):

$$\frac{df_1}{dt} + \vec{v} \cdot \vec{\nabla}_r f_1 - \vec{\nabla}_r U \cdot \vec{\nabla}_p f_1$$

$$= \frac{4}{\pi^3} \int d^3k_2 d\Omega \frac{d\sigma_{nn}}{d\Omega} v_{12} \left[f_3 f_4 \left(-f_1 \right) \left(-f_2 \right) - f_1 f_2 \left(-f_3 \right) \left(-f_4 \right) \right]$$

- f is the Wigner transform of the one-body density matrix
- semi-classically, $= f(\vec{r}, \vec{p}, t)$ (number of nucleons/ $d^3r d^3p$ at \vec{r} and \vec{p}).
- BUU can describe nucleon flows, the nucleation of weakly bound light particles and the production of nucleon resonances.
- The production of heavier fragments is a difficult problem. It have been calculated with Anti-Symmetrized Molecular Dynamics (AMD) and other molecular dynamics techniques with mixed success. Such observables are sensitive to fluctuations in the mean field that give rise to spinodal decomposition.
- The most accurately predicted observables are those that can be calculated from $f(\vec{r}, \vec{p}, t)$ i.e. flows and other average properties of the events.

Some technical points

- Semi-classical: “time dependent Thomas-Fermi theory”
 - Respect of Pauli principle is assured by Liouville's theorem and by the blocking factors in the collision integral.
- Each nucleon is represented by ~ 1000 test particles/nucleon that propagate classically under the influence of the self-consistent mean field U and subject to collisions due to the residual interaction.
 - QMD basically does the same thing with one test particle/nucleon
- Mean field is momentum dependent:
 - Momentum dependence of N-N interaction
 - Fock term
 - Exercise: show that first order term in expansion (in p^2) of momentum dependent mean field potential can be combined with $p^2/(2m)$ to give $p^2/(2m_{\text{eff}})$, which defines the “effective mass”.
- Nucleon-nucleon cross sections are modified in the medium

Procedure to study EOS using transport theory

- Measure collisions
- Simulate collisions with BUU or other transport theory
- Identify observables that are sensitive to EOS (see Danielewicz et al., Science 298,1592 (2002). for flow observables)
 - Directed transverse flow (in-plane) ►
 - “Elliptical flow” out of plane, e.g. “squeeze-out”
 - Kaon production. (Schmah, PRC C **71**, 064907 (2005))
 - Isospin diffusion
 - Neutron vs. proton emission and flow.
 - Pion production.
- Find the mean field(s) that describes the data. If more than one mean field describes the data, resolve the ambiguity with additional data.
- Constrain the effective masses and in-medium cross sections by additional data.
- Use the mean field potentials to calculate the EOS.

symmetric
matter EOS

symmetry
energy

•quick

•detailed

Constraining the EOS at high densities by laboratory collisions

Au+Au collisions $E/A = 1$ GeV

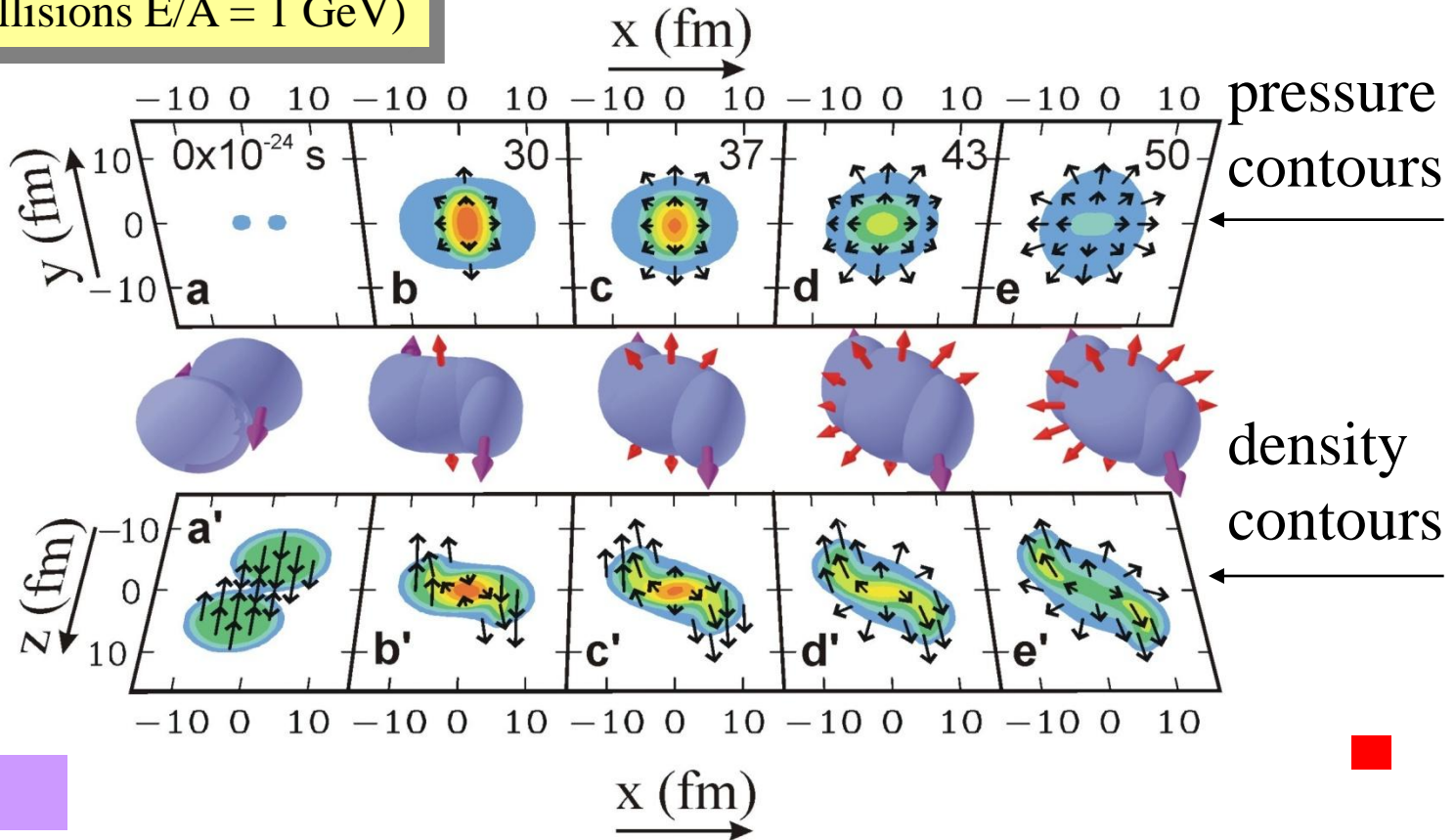

• quick

- Two observable consequences of the high pressures that are formed:
 - Nucleons deflected sideways in the reaction plane.
 - Nucleons are “squeezed out” above and below the reaction plane. .

Directed transverse flow

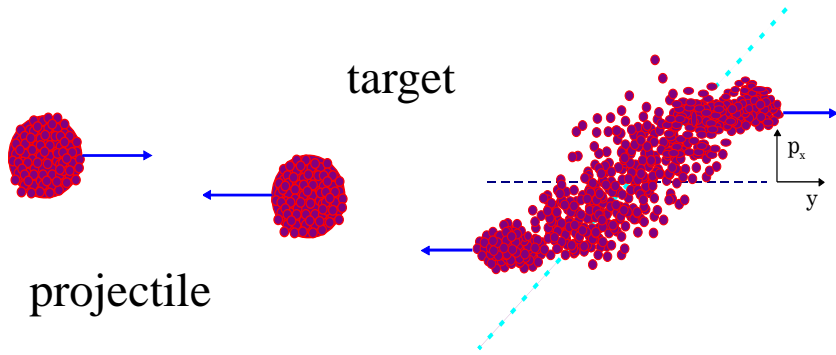

- Event has “elliptical” shape in momentum space, with the long axis in the reaction plane $\perp \vec{J}_{\text{total}}$
- Analysis procedure:
 - Select impact parameter.
 - Find the reaction plane.
 - Determine $\langle p_x(y) \rangle$ in this plane

– note:
$$y = \frac{1}{2} \ln \left(\frac{E + p_z c}{E - p_z c} \right) \Rightarrow \frac{v_{\parallel}}{c}$$
 non-relativistically

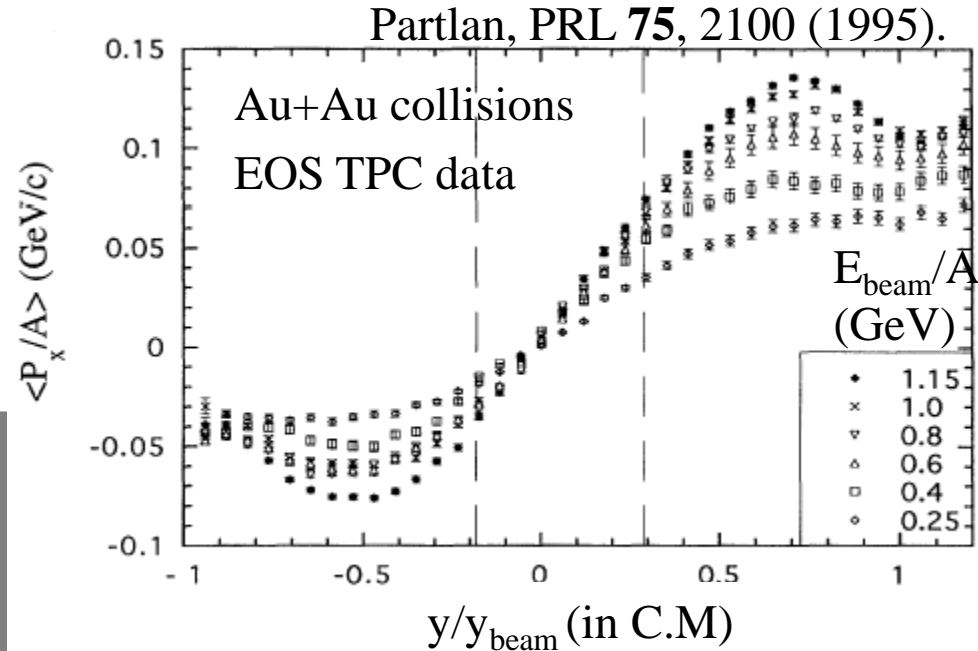

- The data display the “s” shape characteristic of directed transverse flow.
 - Should be symmetric but the TPC has inefficiencies at $y/y_{\text{beam}} < -0.2$.
 - Slope $d \langle p_x/A \rangle / dy$ is determined at $-0.2 < y/y_{\text{beam}} < 0.3$

Determination of symmetric matter EOS from nucleus-nucleus collisions

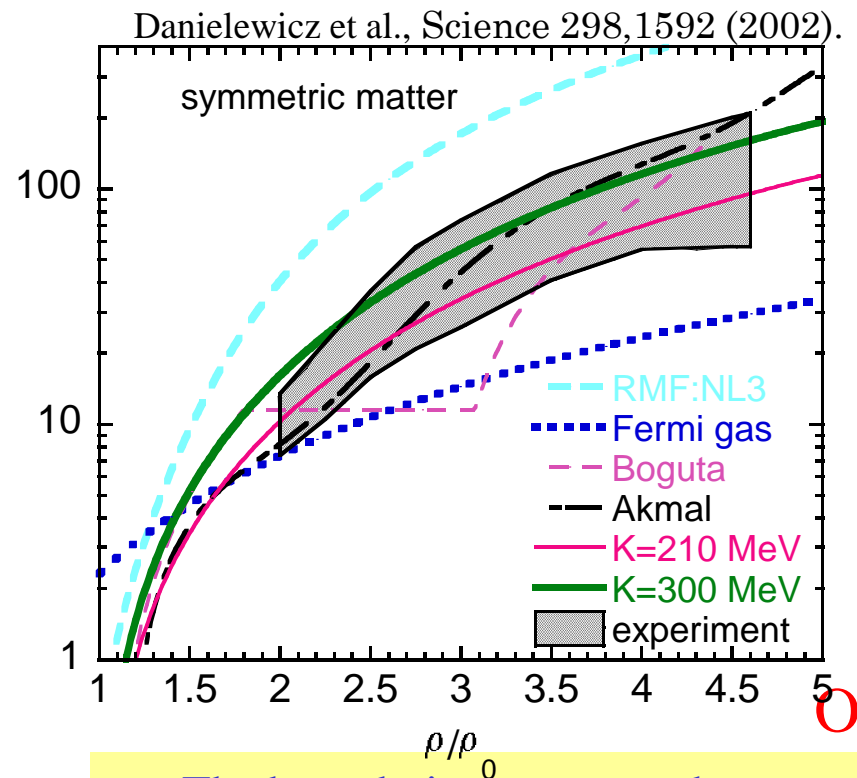
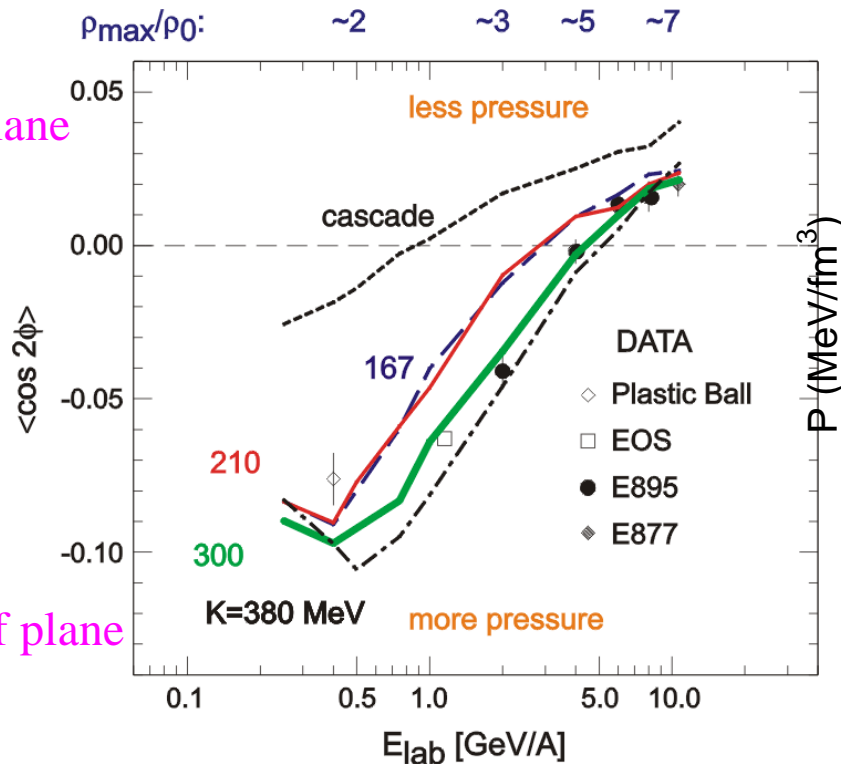

- The curves labeled by K_{nm} represent calculations with parameterized Skyrme mean fields
 - They are adjusted to find the pressure that replicates the observed transverse flow.

- The boundaries represent the range of pressures obtained for the mean fields that reproduce the data.
- They also reflect the uncertainties from the effective masses and in-medium cross sections.

Constraints from collective flow on EOS at $\rho > 2 \rho_0$.

$$E/A(\rho, \delta) = E/A(\rho, 0) + \delta^2 \cdot S(\rho)$$

$$\delta = (\rho_n - \rho_p) / (\rho_n + \rho_p) = (N - Z) / A \approx 1$$

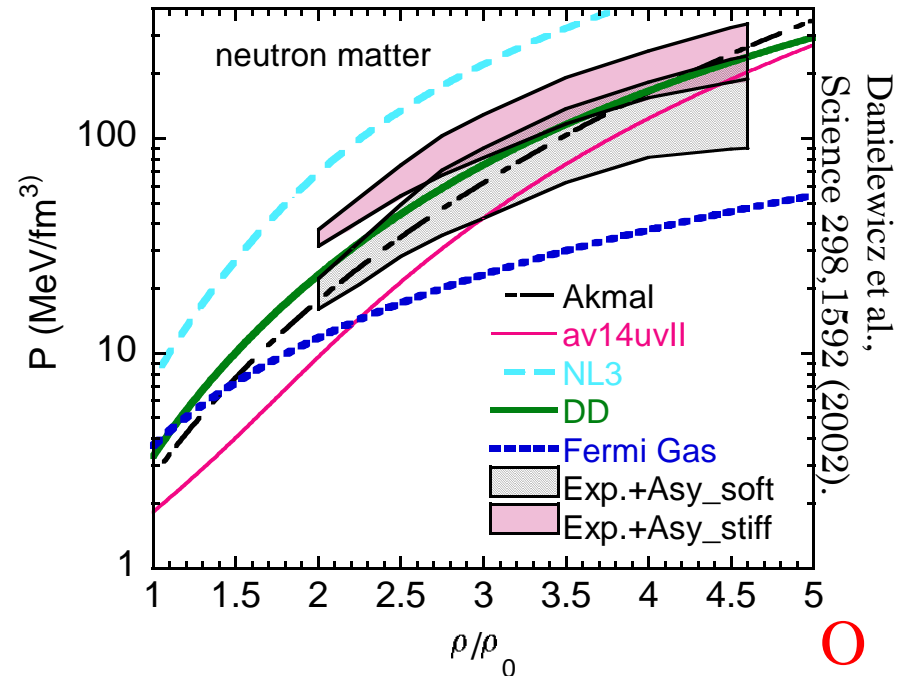
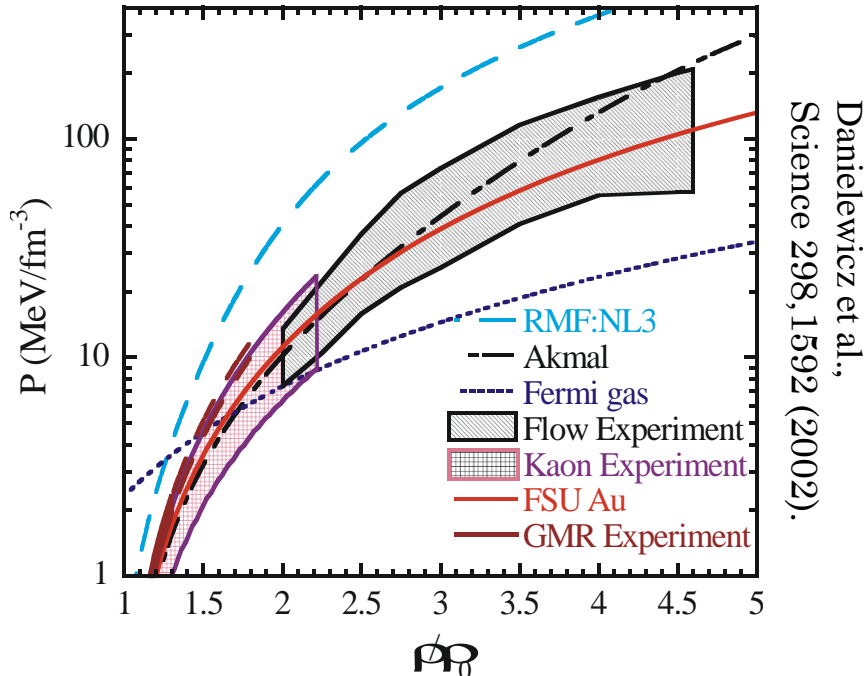

- Note: analysis required additional constraints on m^* and σ_{NN} .
- Flow confirms the softening of the EOS at high density.
- Constraints from kaon production are consistent with the flow constraints and bridge gap to GMR constraints.

- The symmetry energy dominates the uncertainty in the n-matter EOS.
- Both laboratory and astronomical constraints on the density dependence of the symmetry energy are urgently needed.

Impact parameter and reaction plane determination

- Multiplicity decreases monotonically with impact parameter. Can invert the multiplicity to get b/b_{\max} .

$$\frac{dP}{dN_c} \frac{N_c}{dN_c} dN_c = \text{const.} \cdot 2\pi b db \Rightarrow \frac{b}{b_{\max}} = \int_{N_c}^{\infty} \frac{dP}{dN_c} \frac{N_c}{dN_c}$$

- Can get b_{\max} by measuring the cross section

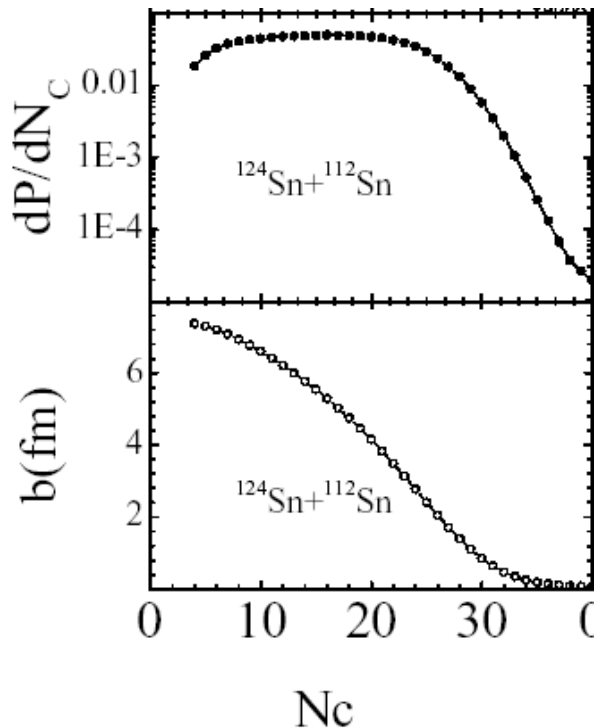

$$\vec{Q} = \sum_i w_i(y_i) \frac{\vec{p}_i^\perp}{|\vec{p}_i^\perp|}$$

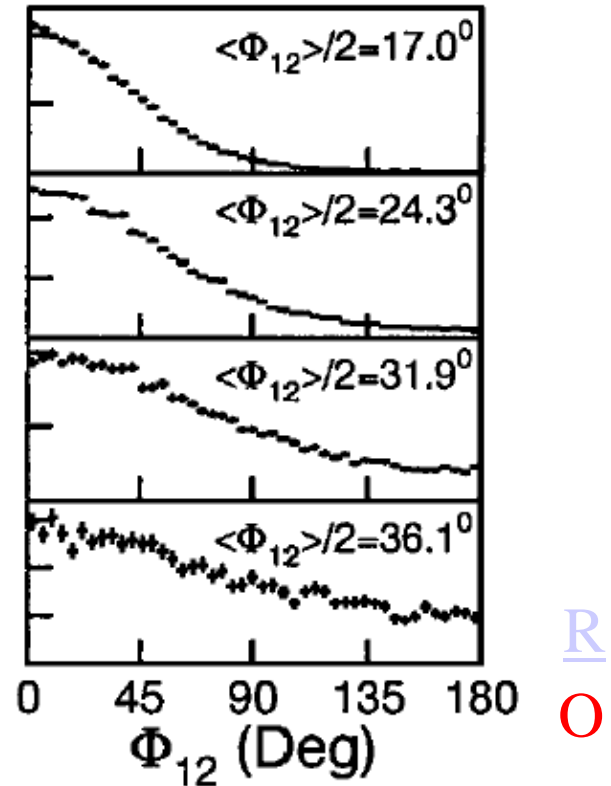

- The reaction plane contains Q and the beam.
- The reaction plane dispersion can be obtained by breaking the event into two sub-events and comparing them.

Theoretical problem: constraining the momentum dependence

- Momentum dependence, e.g. from vector meson exchange or from the Foch term, reduces the effective mass, increasing the acceleration and making the mean field potential appear “stiffer”.
- Ancillary measurements are needed to constrain the momentum dependence
 - Out-of-plane enhancement in peripheral collisions.
 - Measurements of transverse flow in asymmetric systems.

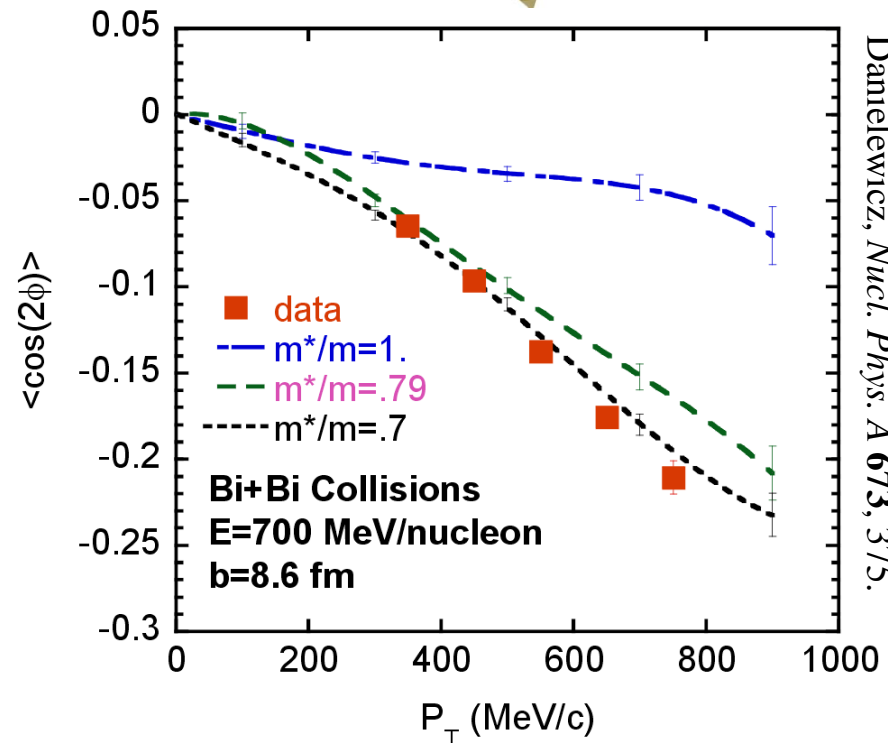
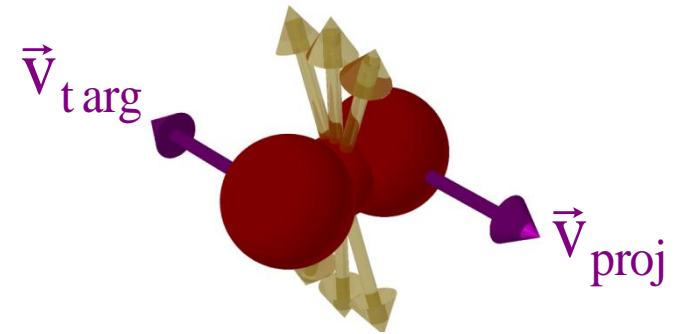

Theoretical problem: constraining σ_{NN}

- The in-medium cross sections also increase pressure and thus can introduce ambiguities.
- The main effect of cross section is to increase the viscosity of nuclear matter – cross sections that yield the same viscosity, predict the same effects. Selected form:

$$\sigma = \sigma_0 \tanh\left(\frac{\sigma_{\text{free}}}{\sigma_0}\right) \text{ where } \sigma_0 = y\rho^{-2/3}$$

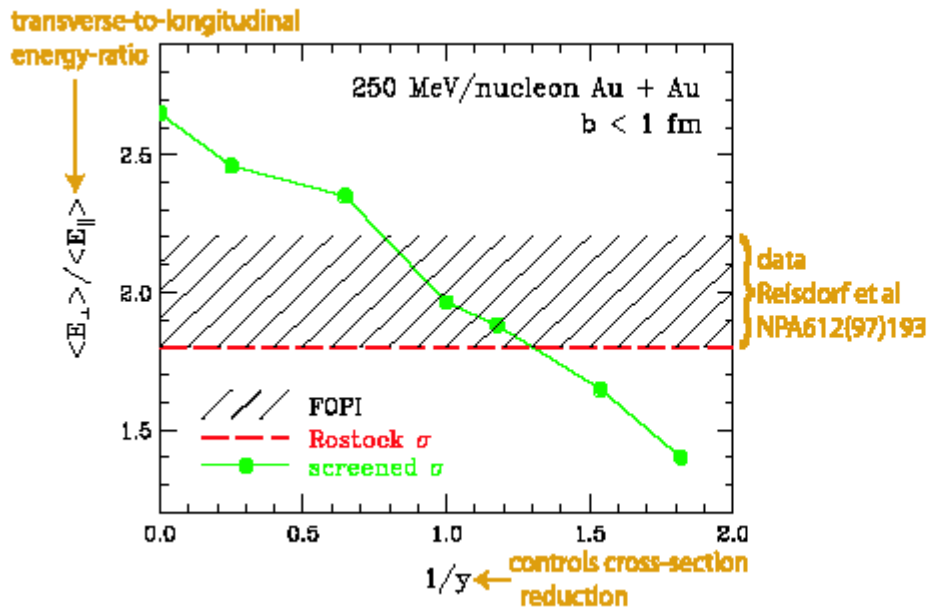

Cross-section reduction R

consistent with FOPI

ERAT = $E_{\perp} / E_{\parallel}$ measurements \circ

Initial:

ERAT = 2: isotropy

ERAT < 2: transparency

ERAT > 2: splashing \perp to the beam axis

Determining the EOS from binding energies

- Mass compilations exist and fitting is straightforward, but there are problems.
 - The Coulomb, volume symmetry and surface symmetry energy terms are strongly correlated.
 - Shell and deformation effects are large.
 - The binding energy formula is not unique. More than one expressions exist that can give roughly equivalent fits, but lead to different conclusions about the surface symmetry energy. For example, authors have taken the following expressions for the symmetry energy:

$$a_{\text{sym},A} \frac{N-Z^2}{A} \quad \text{OR} \quad -a_v b_1 A + a_s b_2 A^{2/3} \frac{N-Z^2}{A^2} \quad \text{OR} \quad \frac{1}{\frac{1}{a_{\text{sym},V}} + \frac{A^{-1/3}}{a_{\text{sym},S}}} \frac{N-Z^2}{A}$$

- The third expression may be the most reasonable. See Danielewicz, Nucl. Phys. A 727 (2003) 233
- The best fits may not even give the most reasonable parameters:
 - Care is needed.

Minimizing uncertainties using analog states

- Coulomb energy shifts can be removed by comparing states with different T in the same nucleus ($T_z=(N-Z)/2$)

$$E_{\text{sym}} \approx a_{\text{sym},A} \frac{N-Z}{A} = \frac{4 \cdot a_{\text{sym},A}}{A} T_z^2$$

$$\Rightarrow \frac{4 \cdot a_{\text{sym},A}}{A} \langle T^2 \rangle = \frac{4 \cdot a_{\text{sym},A}}{A} T(T+1)$$

$$E_{T_2, Z} - E_{\text{GS}, T_1, Z} = \frac{4 \cdot a_{\text{sym},A}}{A} \Delta \langle T^2 \rangle$$

redefining the symmetry energy

- Can be inverted to obtain $a_{\text{sym},A}$

$$\frac{1}{a_{\text{sym},A}} = \frac{4\Delta T^2}{A\Delta E} = \frac{1}{a_{\text{sym},V}} + \frac{A^{-1/3}}{a_{\text{sym},S}}$$

- Hartree-Fock calculations can be used to relate $a_{\text{sym},S}$ to the density dependence of the symmetry energy at subsaturation ($\sim \rho/2$) density.

- The resulting constraints will be shown later

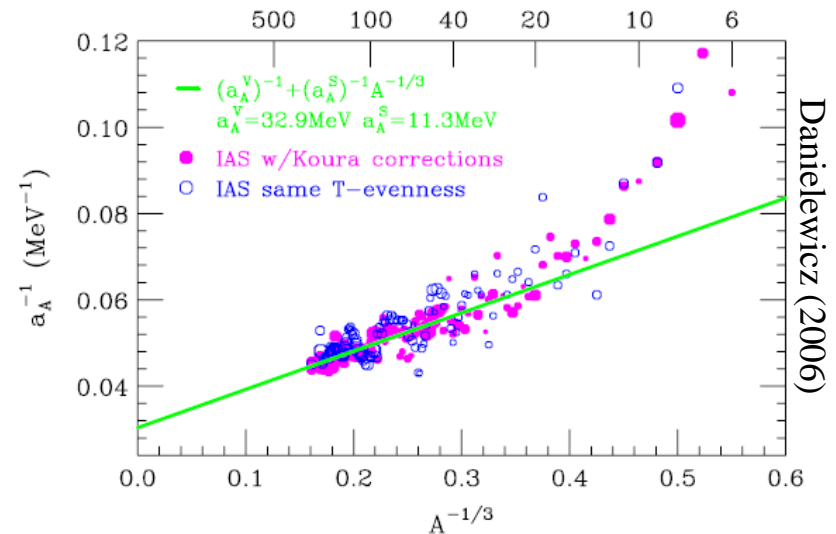
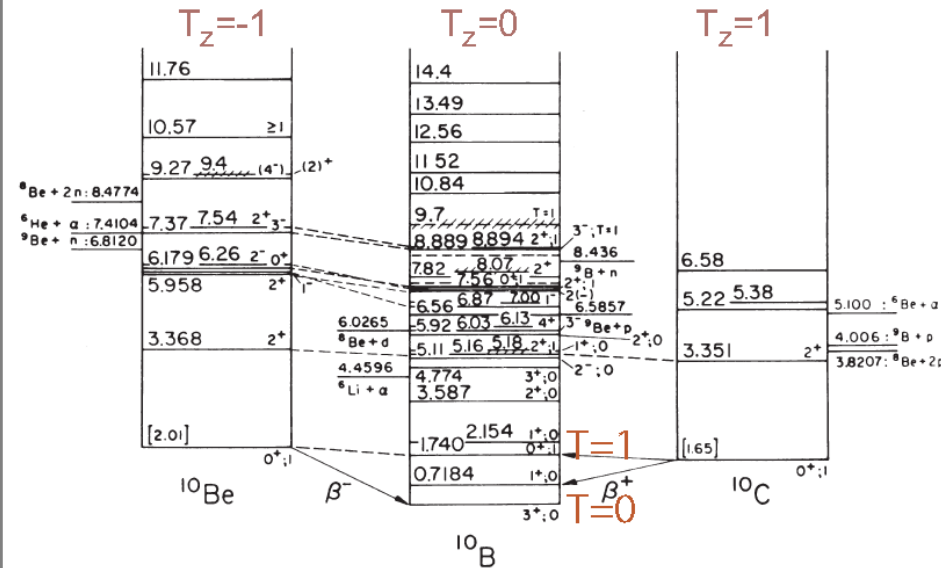

Summary of last lecture

- The symmetry energy has a profound influence on neutron star properties: stellar radii, maximum masses, cooling of proto-neutron stars, phases in the stellar interior, etc.
- The high density behavior of the symmetric matter EoS has some initial constraints from the GMR energy, from collective flow and from Kaon production.
 - The pressures achieved in high energy collisions are of the order of 10^{35} N/m²!
- The behavior at large isospin asymmetries of the EOS is not well constrained.
- The behavior at large isospin asymmetries is described by the symmetry energy.
 - Nuclear masses can provide information about the symmetry energy

Another observable: comparisons of $\langle r^2 \rangle_n^{1/2}$ and $\langle r^2 \rangle_p^{1/2}$

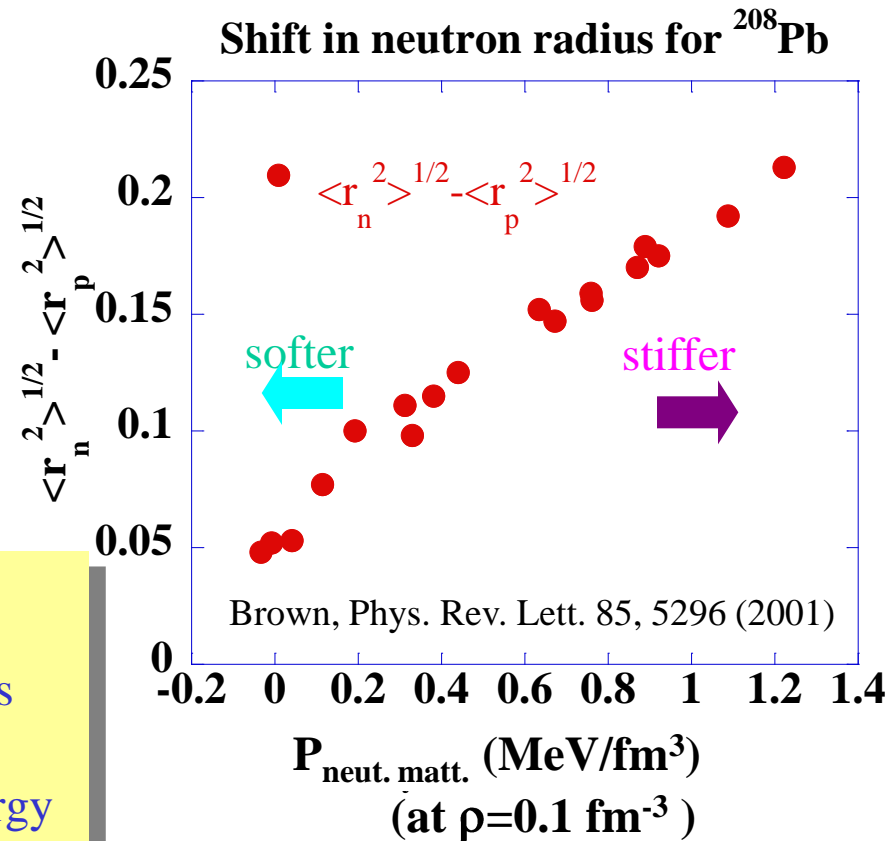
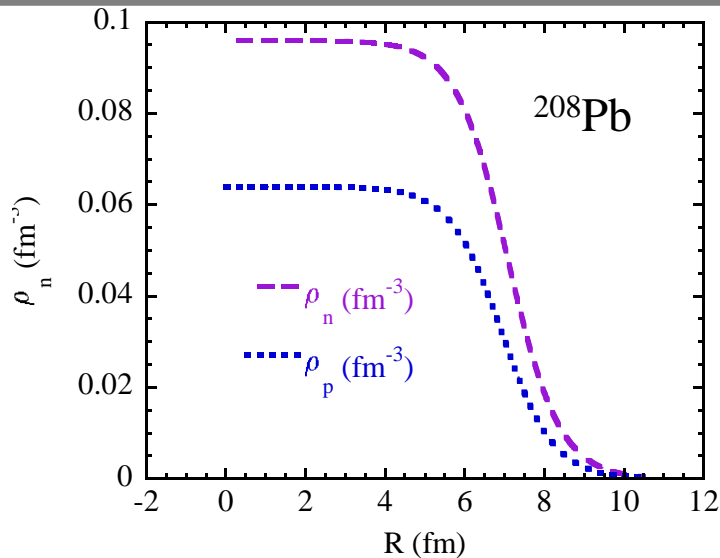

- Approximating the density profile by a Fermi function $\rho(r) = \rho_0 / (1 + \exp((r-R)/a))$, we show representative proton and neutron distributions for ^{208}Pb .
- Calculations predict that a stiff symmetry energy will result in a larger neutron skin.
 - Neutron pressure increases and surface energy decreases when $S(\rho)$ becomes more strongly density dependent. Both effects shift more neutrons to the surface.
- Relation between skin thickness and EoS is somewhat model dependent

$$P_{\text{neut_matt}} = P_{\text{sym_matt}} + P_{\text{sym}}$$

$$P_{\text{sym}} = \frac{\rho^2 \partial S}{\partial \rho} \Big|_{T, \delta}$$

Measurements of radii

- Parity violating electron scattering (PREX exp.) may provide strong constraints on $\langle r_n^2 \rangle^{1/2} - \langle r_p^2 \rangle^{1/2}$ and on $S(\rho)$ for $\rho < \rho_s$. Expected uncertainties are of order 0.06 fm. (see Horowitz et al., Phys. Rev. 63, 025501(2001).)
- Nuclear charge and matter radii are often measured by diffractive scattering.
- For example, $\langle r_p^2 \rangle^{1/2}$ has been measured stable nuclei, by electron scattering to about 0.02 fm accuracy.
 - (see G. Fricke et al., At. Data Nucl. Data Tables 60, 177 (1995).)
- Strong interaction shifts in the $4f \rightarrow 3d$ transition in pionic ^{208}Pb also provide sensitivity to the rms neutron radius. (Garcia-Recio, NPA 547 (1992) 473)
 - $\langle r_n^2 \rangle^{1/2} = 5.74 \pm 0.07_{\text{ran}} \pm 0.03_{\text{sys}}$ fm
 - $\langle r_n^2 \rangle^{1/2} - \langle r_p^2 \rangle^{1/2} = 0.22 \pm 0.07_{\text{ran}} \pm 0.03_{\text{sys}}$ fm

- Proton elastic scattering is sensitive to the neutron density, but the results can be ambiguous.

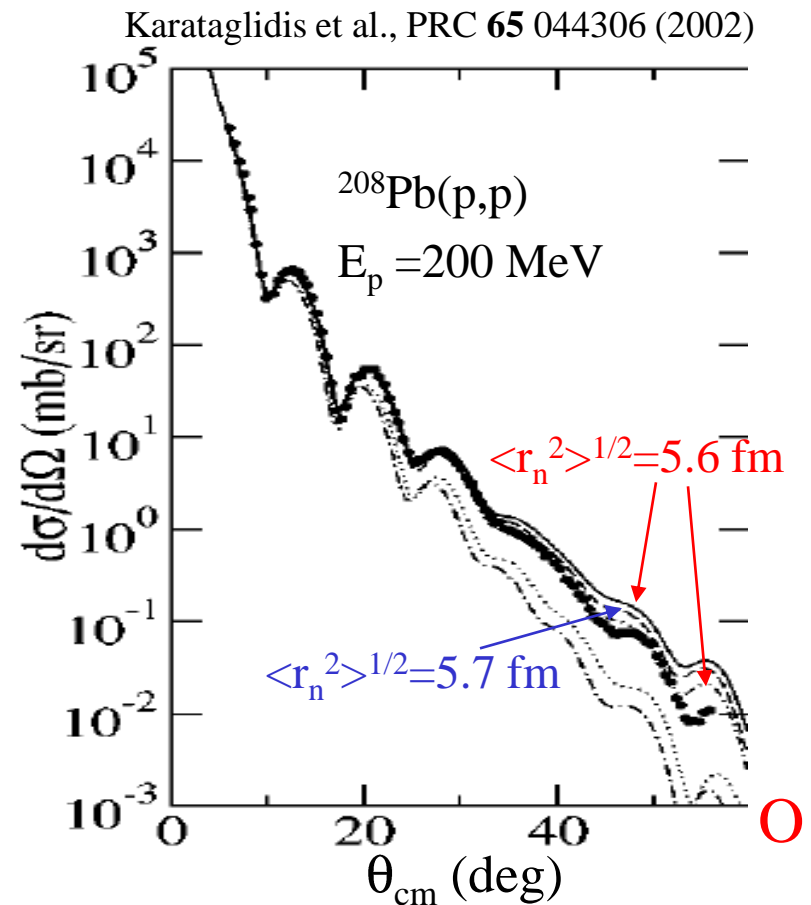

Radii of Na isotopes

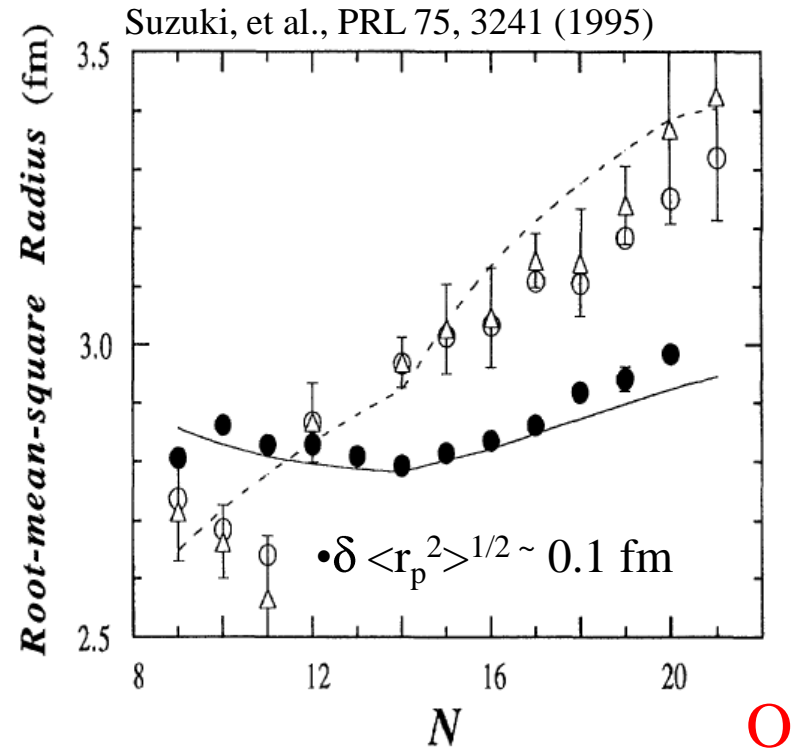
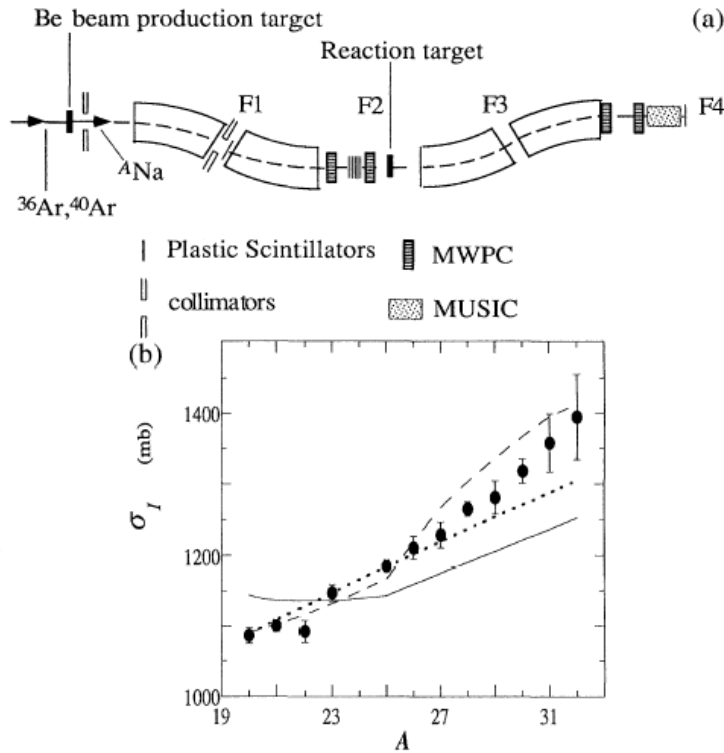

$$N_{\text{transmitted}} = N_{\text{incident}} \exp\left(-\sigma_{\text{int}} \rho_c \Delta X\right)$$

- The relationship between cross-section and Na interaction radius is:

$$\sigma_{\text{int}} = \pi(R_{c,\text{int}} + R_{\text{Na,int}})^2$$

- Getting the actual neutron radius is model dependent.

- Proton radii are determined by measuring atomic transitions in Na, which has a 3s g.s. orbit.
- Neutron radii increase faster than $R=r_0 A^{1/3}$, reflecting the thickness of neutron skin, e.g. RMF calculation.

Electric dipole excitations of the neutron skin

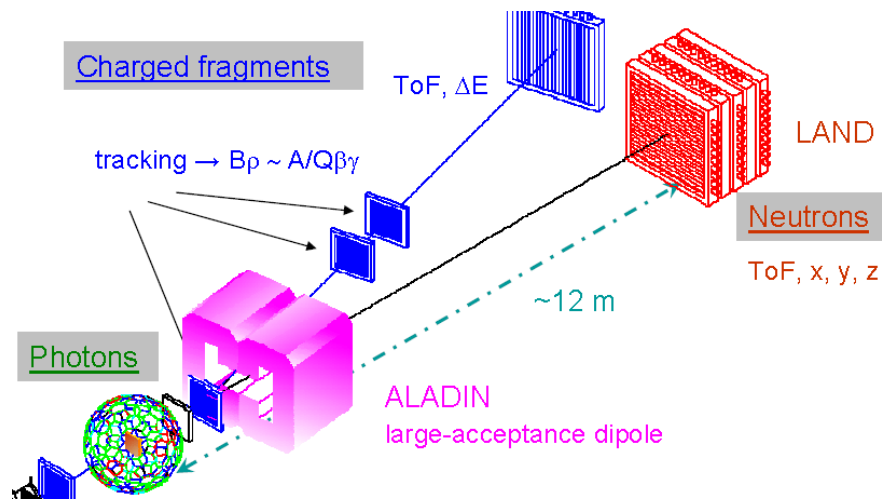

- Coulomb excitation of very neutron rich $^{130,132}\text{Sn}$ isotopes reveals a peak at $E^* \approx 10$ MeV.
 - not present for stable isotopes
- Consistent with low-lying electric dipole strength.
- calculations suggest an oscillation of a neutron skin relative to the core.

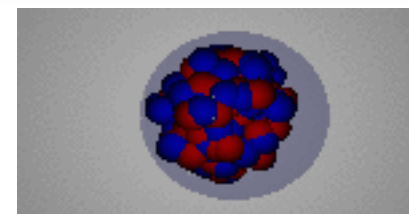
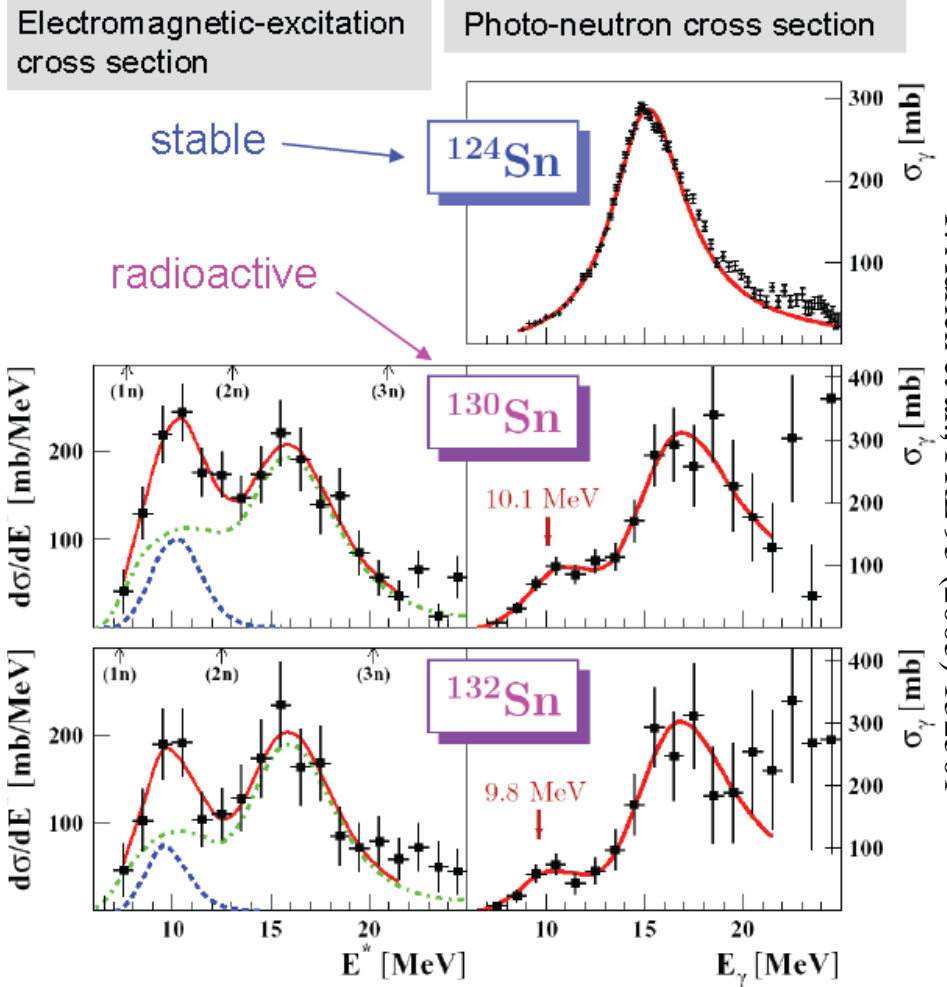

Relation to symmetry energy

A. Klimkiewicz, et al., PRC76, 051603(R) (2007)

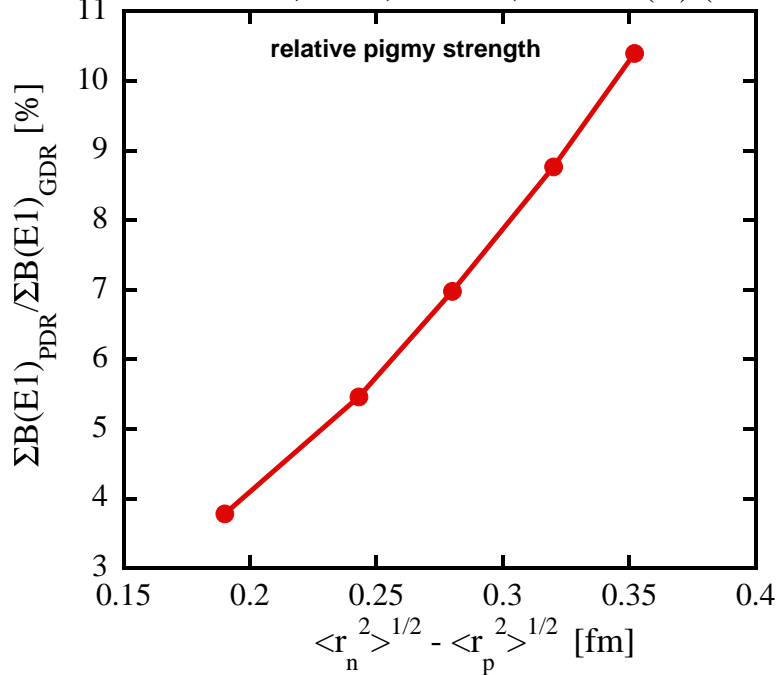

A. Carbone, et al., PRC 81, 041301(R) (2010)

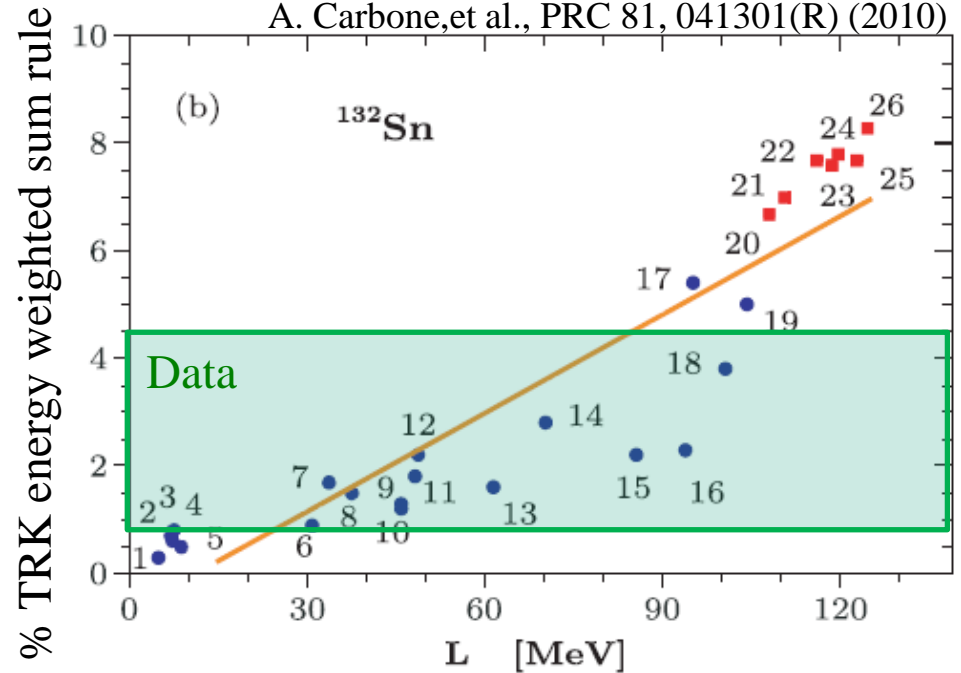

- Random phase approximation (RPA) calculations show a strong correlation between the neutron - proton radius difference and the fractional strength in the pygmy dipole resonance.

- Random phase approximation (RPA) calculations show a strong correlation between the fractional strength and

$$L = 3\rho_0 \left. \frac{\partial E_{\text{sym}}}{\partial \rho_B} \right|_{\rho_B = \rho_0} = \frac{3}{\rho_0} P_{\text{sym}} \rho_0$$

Giant resonances

- Imagine a macroscopic, i.e. classical vibration of the matter in the nucleus.
 - e.g. Isoscalar Giant Monopole (GMR) resonance
- GMR and also ISGDR provide information about the curvature of $\epsilon(\rho,0,0)$ about minimum.

$$\epsilon(\rho,0,0) \approx -16\text{MeV} + \frac{1}{2} \frac{\partial^2 \epsilon}{\partial \rho^2} (\rho - \rho_s)^2$$
- Inelastic α particle scattering e.g. $^{90}\text{Zr}(\alpha, \alpha') ^{90}\text{Zr}^*$ can excite the GMR. (see Youngblood et al., PRL 92, 691 (1999).)
 - Peak is strongest at 0°

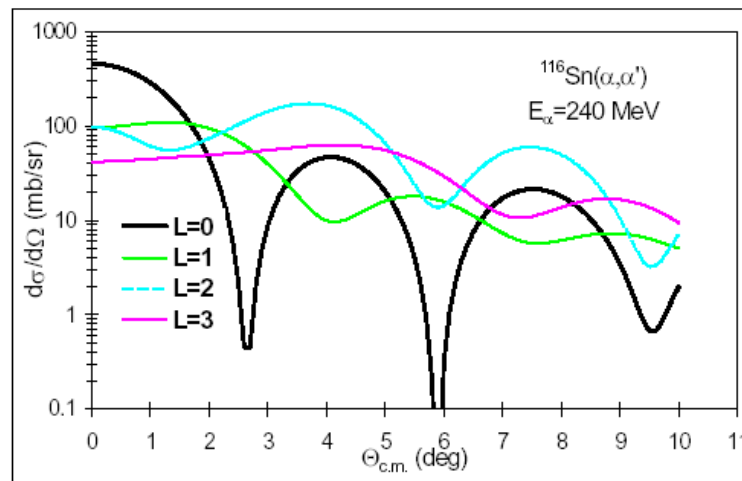
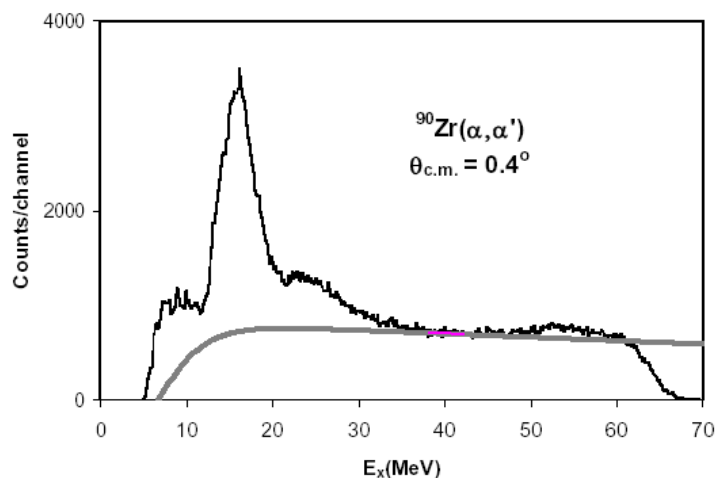
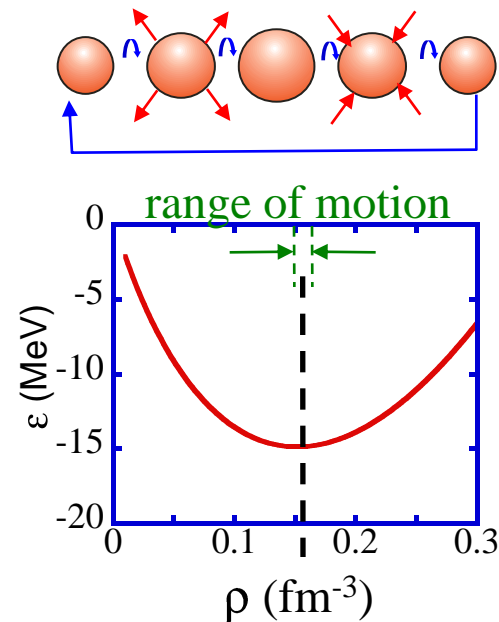

Giant resonances 2

- This motivates a "leptodermous" expansion (see Harakeh and van der Woude, "Giant Resonances" Oxford Science...):

$$K_A = K_V + K_{\text{surf}} A^{-1/3} + K_{\text{sym}} \cdot \delta^2 + K_{\text{Coul}} \cdot Z^2 / A^{4/3}$$

- K_{sym} is a function of the first and second derivatives of the symmetry energy (G. Colo, *et al.*, Phys. Rev. C70, 024307 (2004).)

$$K_{\text{sym}} = 9\rho_0^2 \frac{\partial^2 S}{\partial \rho^2} \Big|_{\sigma, \delta} + 9\rho_0 \frac{\partial S}{\partial \rho} \Big|_{\sigma, \delta} - \frac{81\rho_0^3}{K_V} \frac{\partial S}{\partial \rho} \Big|_{\sigma, \delta} \frac{\partial^3 \rho \epsilon}{\partial \rho^3} \Big|_{\sigma, \delta}$$

- Measurements of GMR resonance energies over a range of isotopes may provide information the first and second derivatives of the symmetry energy as a function of density! (Actually, the first derivative is more important)

Isotopic dependence of the GMR

- The shift in the monopole resonance energy with neutron number provides a measurement of K_{sym} .

- After subtraction of surface and coulomb contributions

$$K_{\text{sym}} \cdot \delta^2 = K_A - K_{\text{nm}} - K_{\text{surf}} A^{-1/3} - K_{\text{Coul}} \cdot Z^2 / A^{4/3}$$

- The GMR energy decreases by about 0.8 MeV between ^{112}Sn and ^{124}Sn .
 - K_A decreases with asymmetry δ
 - Most comes from K_{sym}
- Value for K_{sym}

$$K_{\text{sym}} = -550 \pm 100 \text{ MeV}$$

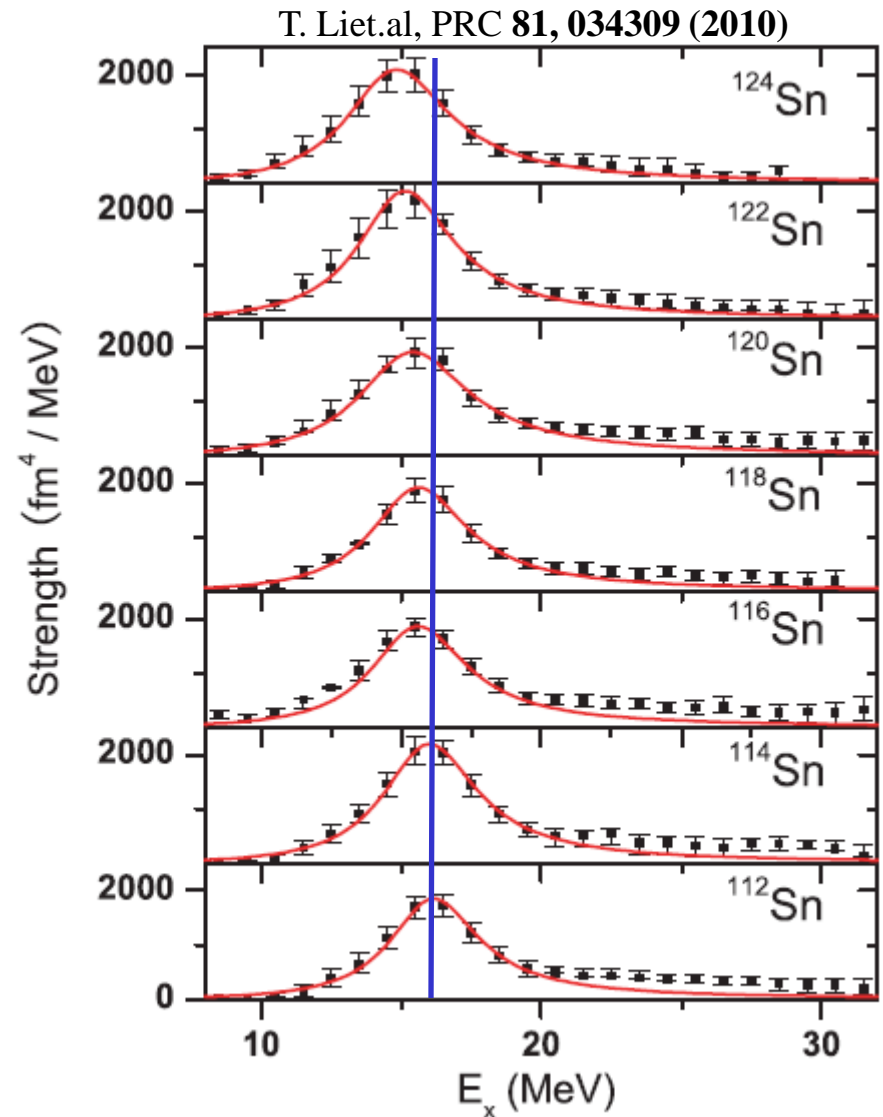

Probing the symmetry energy by nuclear collisions

$$E/A(\rho, \delta) = E/A(\rho, 0) + \delta^2 \cdot S(\rho) ; \quad \delta = (\rho_n - \rho_p) / (\rho_n + \rho_p) = (N-Z)/A$$

- To maximize sensitivity, reduce systematic errors:
 - Vary isospin of detected particle
 - Vary isospin asymmetry $\delta=(N-Z)/A$ of reaction.
- Low densities ($\rho < \rho_0$):
 - Neutron/proton spectra and flows
 - Isospin diffusion
- High densities ($\rho \approx 2\rho_0$):
 - Neutron/proton spectra and flows
 - π^+ vs. π^- production

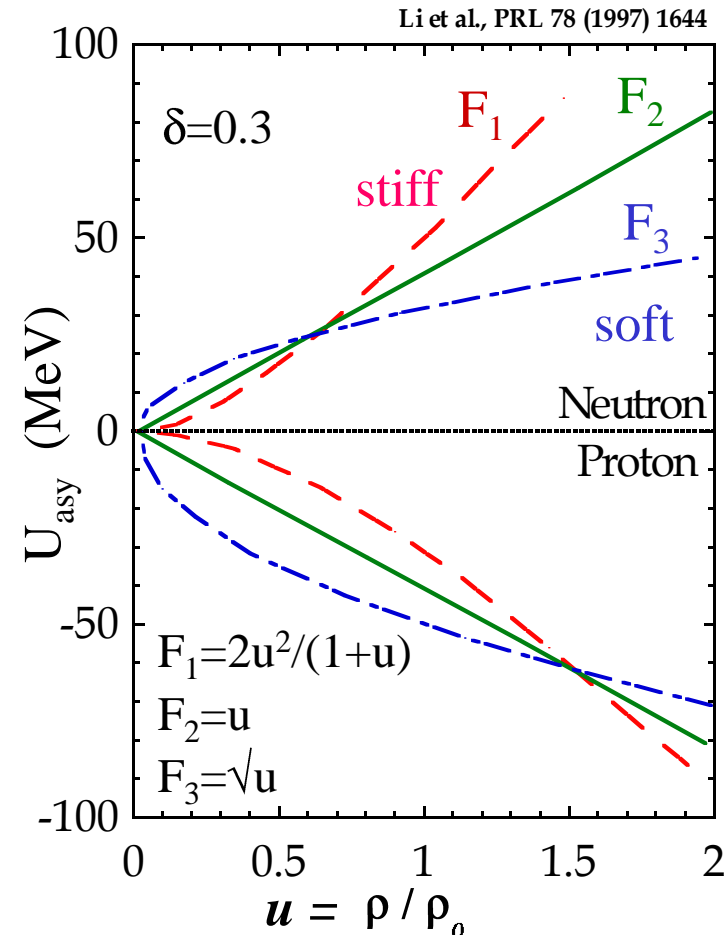

Probe: Isospin diffusion in peripheral collisions

- Collide projectiles and targets of differing isospin asymmetry
- Probe the asymmetry $\delta=(N-Z)/(N+Z)$ of the projectile spectator during the collision.
- The use of the isospin transport ratio $R_i(\delta)$ isolates the diffusion effects:

$$R_i(\delta) = 2 \cdot \frac{\delta - (\delta_{\text{both_neut-rich}} + \delta_{\text{both_prot-rich}}) / 2}{\delta_{\text{both_neut-rich}} - \delta_{\text{both_prot-rich}}}$$

- Useful limits for R_i for $^{124}\text{Sn}+^{112}\text{Sn}$ collisions:
 - $R_i = 1$: no diffusion
 - $R_i \approx 0$: Isospin equilibrium

Systems {

- mixed $^{124}\text{Sn}+^{112}\text{Sn}$
- n-rich $^{124}\text{Sn}+^{124}\text{Sn}$
- p-rich $^{112}\text{Sn}+^{112}\text{Sn}$

Example:

proton-rich target

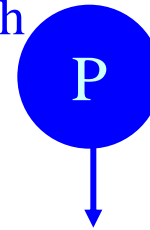

neutron-rich projectile



measure asymmetry after collision



What influences isospin diffusion?

- Isospin diffusion equation:

$$\vec{j}_n - \vec{j}_p = -\rho D_\delta \vec{\nabla} \delta - D_\rho \delta \vec{\nabla} \rho$$
- Naive expectations:
 - D_δ increases with $S(\rho)$
 - D_δ decreases with σ_{np}
- We tested this by performing extensive BUU and QMD calculations with $S(\rho)$ for the form:
 - $S(\rho) = 12.5 \cdot (\rho/\rho_0)^{2/3} + S_{int} \cdot (\rho/\rho_0)^{\gamma_i}$
- Observed sensitivities:
 - Diffusion sensitive to $S(0.4\rho_0)$
 - Diffusion increases with S_{int} and decreases with γ_i
 - Diffusion decreases with σ_{np}
 - Diffusion decreases when mean fields are momentum.
 - Diffusion decreases with cluster production.

Main effect

important for other observables

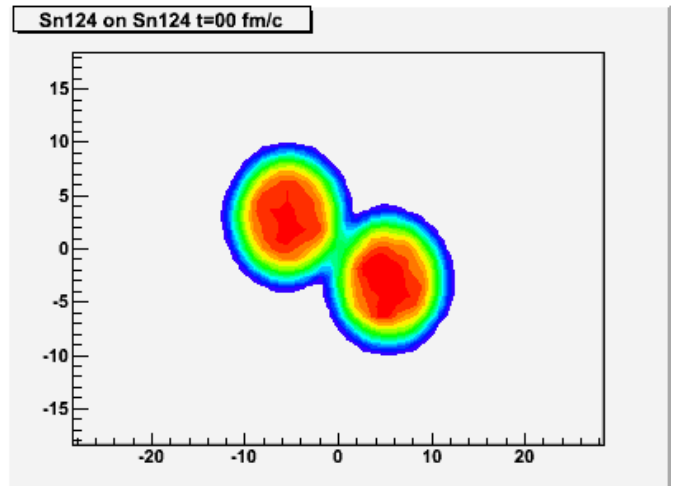
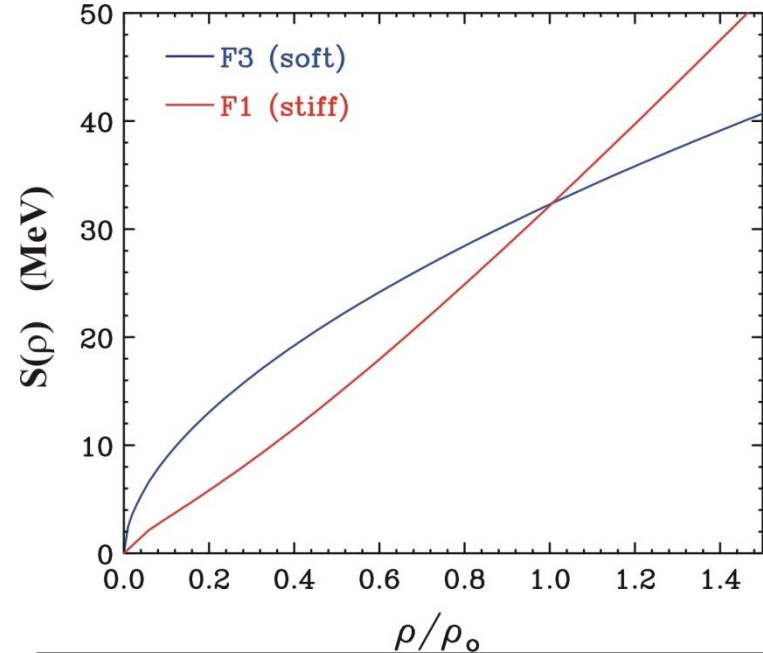

Summary of last lecture

- The symmetry energy can be probed at sub-saturation densities by various nuclear structure observables.
 1. Binding energies
 2. Radii of neutron and proton matter in nuclei
 3. “Pygmy” Resonance
 4. Giant Monopole Resonance
- There are a number of reaction observables that may provide information at the symmetry energy.
- Low densities ($\rho < \rho_0$):
 - Neutron/proton spectra and flows
 - Isospin diffusion
- High densities ($\rho \approx 2\rho_0$) :
 - Neutron/proton spectra and flows
 - π^+ vs. π^- production
- Isospin diffusion is sensitive to the symmetry energy at about $0.4 \rho_0$
 - Begin to describe the isospin diffusion phenomenon and how it might be measured.

Sensitivity to symmetry energy

$$R_i(\delta) = 2 \cdot \frac{\delta - (\delta_{\text{Neutron-rich}} + \delta_{\text{Proton-rich}}) / 2}{\delta_{\text{Neutron-rich}} - \delta_{\text{Proton-rich}}}$$

- The asymmetry of the spectators can change due to diffusion, but it also can be changed due to pre-equilibrium emission.
- The use of the isospin transport ratio $R_i(\delta)$ isolates the diffusion effects:

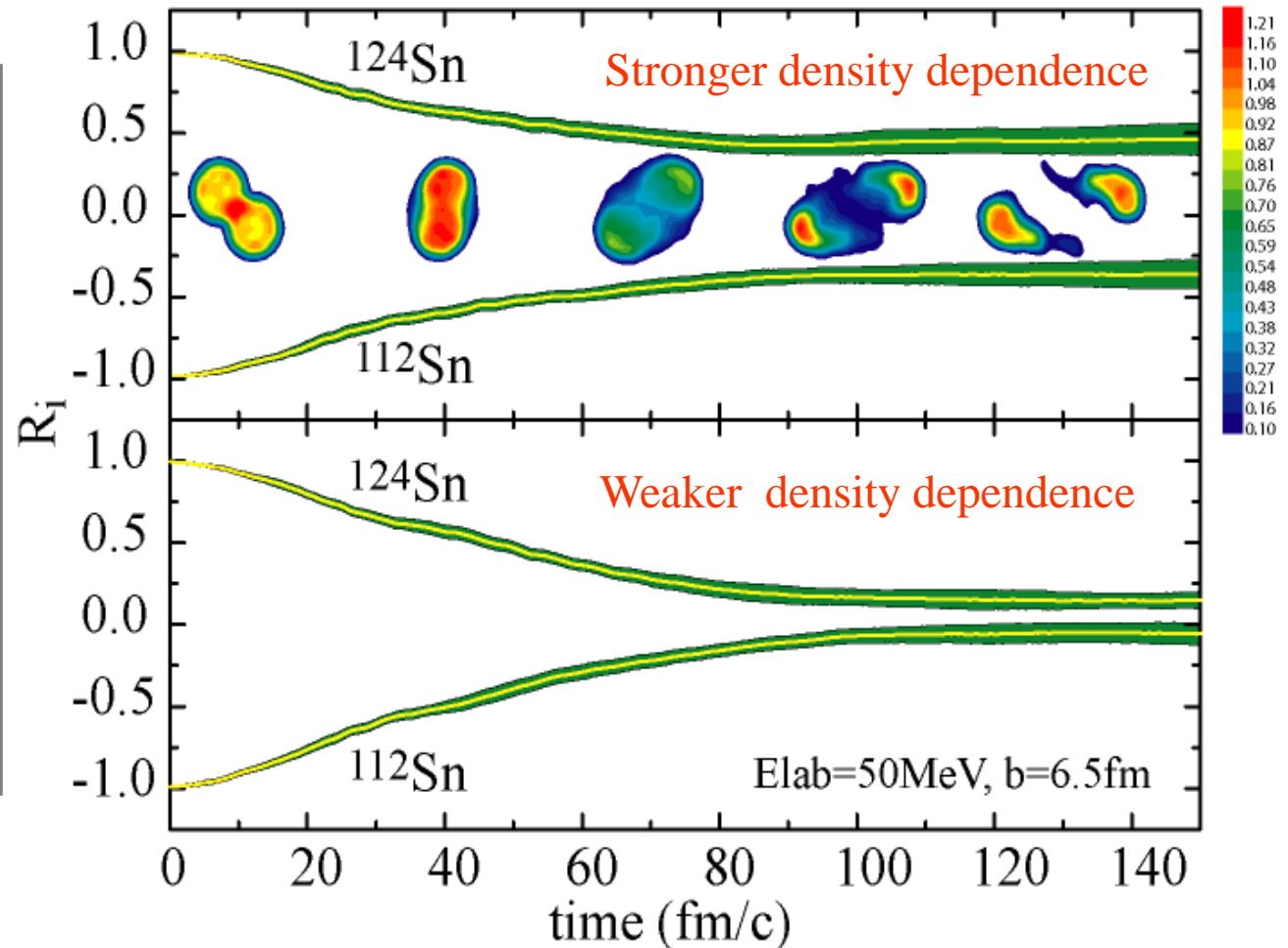

Experimental measurements of isospin diffusion

- Experimental device:

Miniball with LASSA array

Experiment:

$^{112,124}\text{Sn} + ^{112,124}\text{Sn}$, $E/A = 50$ MeV

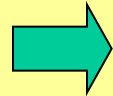

- Projectile and target nucleons are largely “spectators” during these peripheral collisions.
 - Projectile residues have somewhat less than beam velocity.
 - Target residues have very small velocities.

Impact parameter determination

- Multiplicity decreases monotonically with impact parameter. Can invert the multiplicity to get b/b_{\max} .

$$\frac{dP}{dN_c} dN_c = \text{const.} \cdot 2\pi b db \Rightarrow \frac{b}{b_{\max}} = \left(\frac{\int_{N_c}^{N_c} dN_c \frac{dP}{dN_c}}{\int_{N_c}^{\infty} dN_c \frac{dP}{dN_c}} \right)^{1/2}$$

- Can get b_{\max} by measuring the cross section $\sigma(N_c \geq N_c(b_{\max}))$
- Can be done for any observable that depends monotonically on b
 - main problem is that $N_c(b)$ fluctuates, which limits the precision of the impact parameter.
 - fluctuation scan be estimated by transport model calculations.

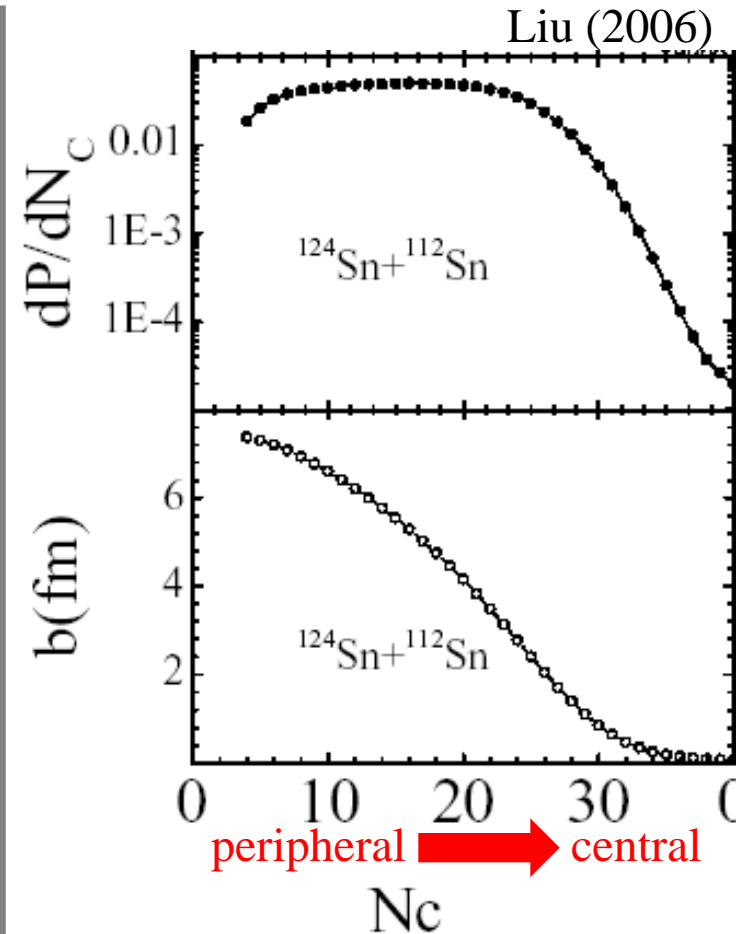

Probing the asymmetry of the projectile spectators: $b=5.8-7.2$ fm $y>0.7y_{\text{beam}}$

- The main effect of changing the asymmetry of the projectile spectator remnant is to shift the isotopic distributions of the products of its decay

- This can be described by the isoscaling parameters α and β :

$$\frac{Y_2(N, Z)}{Y_1(N, Z)} = C \exp(\alpha N + \beta Z)$$

Liu et al. PRC 76, 034603 (2007).

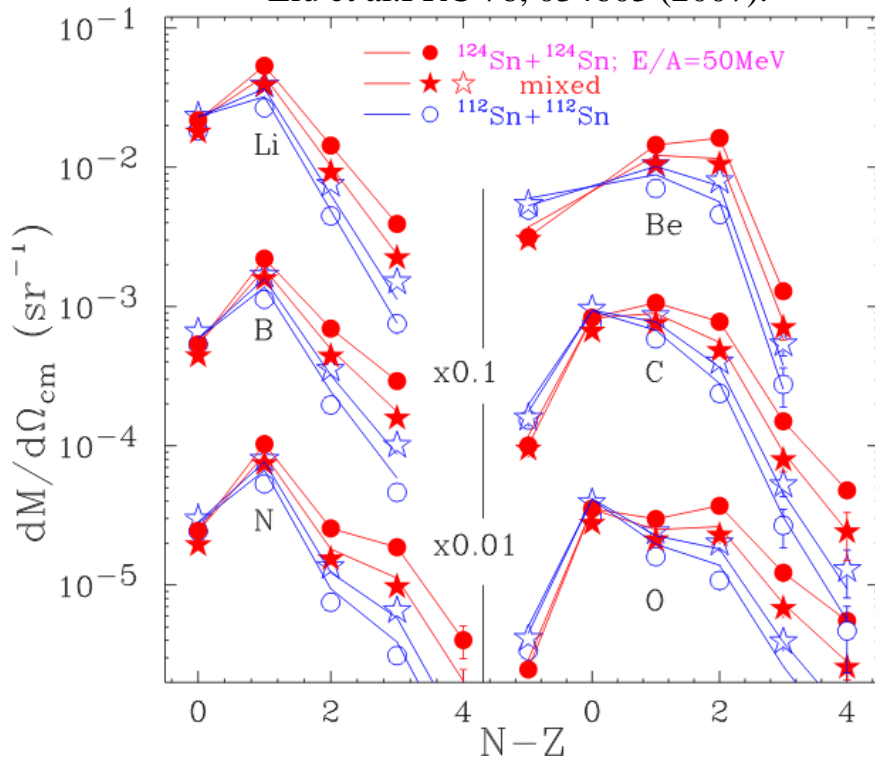

Tsang et al., PRL 92, 062701 (2004)

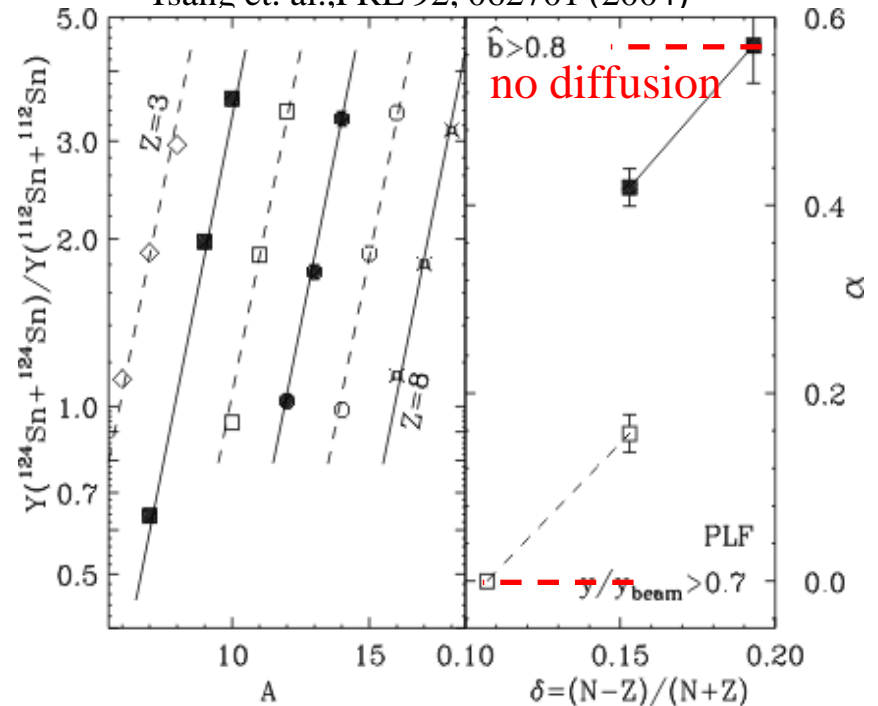

Origin of isoscaling

$$R_{21}(N, Z) \equiv \frac{Y_2(N, Z)}{Y_1(N, Z)} = C \exp(\alpha N + \beta Z)$$

- Isoscaling is a prediction of nearly all statistical models .
- For example, isoscaling parameters have simple origins in the grand canonical ensemble:

$$Y_i(N, Z) \propto \exp\left[\frac{\mu_{N,i} N + \mu_{Z,i} Z - f_{N,Z,int}}{T} \right]$$

$$\rightarrow \alpha = \frac{\mu_{N,2} - \mu_{N,1}}{T} \equiv \frac{\Delta\mu_N}{T}; \beta = \frac{\Delta\mu_Z}{T}$$

- $f_{N,Z,int}$ is the Helmholtz internal free energy of the fragment.
 $f_{N,Z,int} = -T \ln Z_{N,Z,int}$

- Isoscaling parameters for C.N. evaporation are given by the difference between the separation energies for the two systems:

$$R_{21}(N, Z) \approx C \exp\left[\frac{-N \cdot \Delta s_n - Z \cdot \Delta s_p + e\Delta\Phi(Z_{tot} - Z)}{T} \right]$$

- Isoscaling is also predicted by the dynamical AMD model
 - Implies that thermalization occurs rapidly within AMD calculations.

Determining $R_i(\delta)$



$$R_i(\delta) = 2 \cdot \frac{\delta - (\delta_{\text{Neutron-rich}} + \delta_{\text{Proton-rich}}) / 2}{\delta_{\text{Neutron-rich}} - \delta_{\text{Proton-rich}}}$$

$$\frac{Y_2(N, Z)}{Y_1(N, Z)} = C \exp(\alpha N + \beta Z)$$

- In statistical theory, certain observables depend linearly on $\delta = (\rho_n - \rho_p) / \rho$:

$$\alpha = a \delta_2 + b,$$

$$X_7 = \ln \left[\frac{Y(\text{Li})}{Y(\text{Be})} \right] = c \cdot \delta_2 + d$$

- Calculations confirm this 
- We have experimentally confirmed this 

- Consider the ratio $R_i(X)$, where $X = \alpha$, X_7 or some other observable:

$$R_i(X) = 2 \cdot \frac{X - (X_{\text{Neutronrich}} + X_{\text{Protonrich}}) / 2}{X_{\text{Neutronrich}} - X_{\text{Protonrich}}}$$

- If X depends linearly on δ_2 :

$$X = a \cdot \delta_2 + b$$

- Then by direct substitution:

$$R_i(X) = R_i(\delta_2) \quad \img alt="arrow" data-bbox="875 735 910 775"/>$$

Probing the asymmetry of the Spectators

- The main effect of changing the asymmetry of the projectile spectator remnant is to shift the isotopic distributions of the products of its decay

- This can be described by the isoscaling parameters α and β :

$$\frac{Y_2(N, Z)}{Y_1(N, Z)} \approx C \exp(\alpha N + \beta Z)$$

Liu et al. PRC 76, 034603 (2007).

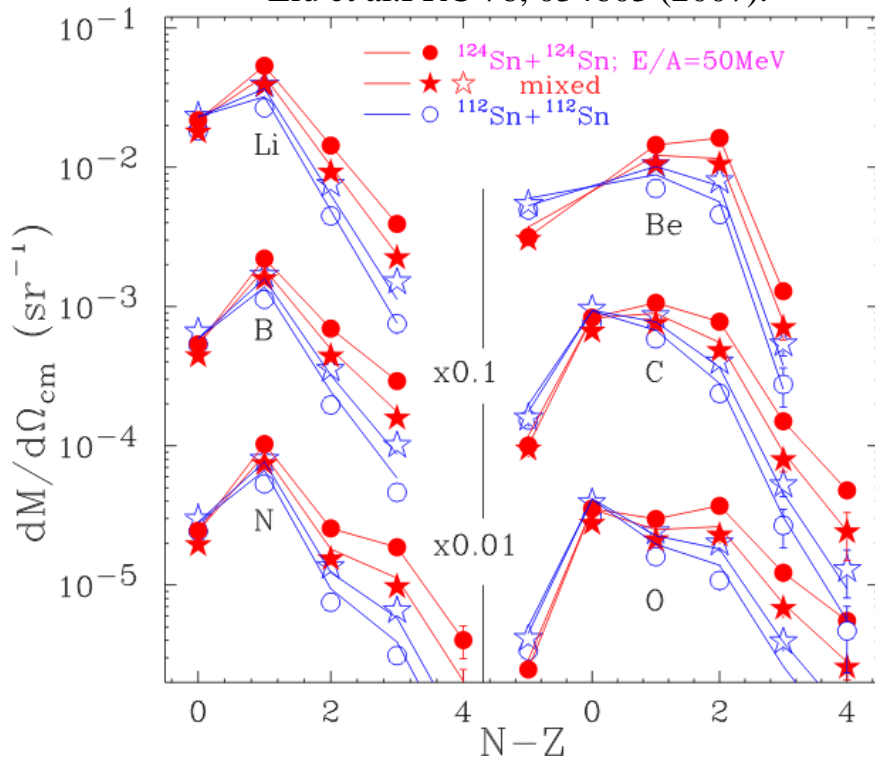

Tsang et al., PRL 92, 062701 (2004)

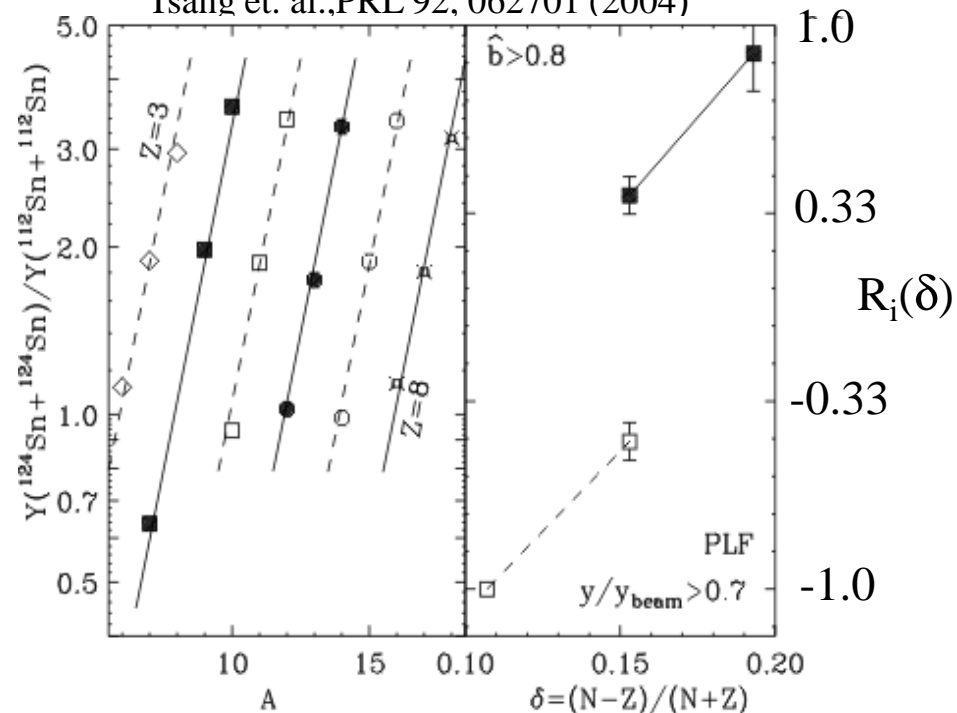

Quantitative values

- Reactions:
 - $^{124}\text{Sn}+^{112}\text{Sn}$: diffusion
 - $^{124}\text{Sn}+^{124}\text{Sn}$: neutron-rich limit
 - $^{112}\text{Sn}+^{112}\text{Sn}$: proton-rich limit
- Exchanging the target and projectile allowed the full rapidity dependence to be measured.
- Gates were set on the values for $R_i(\alpha)$ near beam rapidity.
 - $R_i(\alpha) \approx 0.47 \pm 0.05$ for $^{124}\text{Sn}+^{112}\text{Sn}$
 - $R_i(\alpha) \approx -0.44 \pm 0.05$ for $^{112}\text{Sn}+^{124}\text{Sn}$
- Obtained similar values for $R_i(\ln(Y(^7\text{Li})/ Y(^7\text{Be})))$
 - Allows exploration of dependence on rapidity

$$R_i(\delta) = 2 \cdot \frac{\delta - (\delta_{\text{Neutron-rich}} + \delta_{\text{Proton-rich}}) / 2}{\delta_{\text{Neutron-rich}} - \delta_{\text{Proton-rich}}}$$

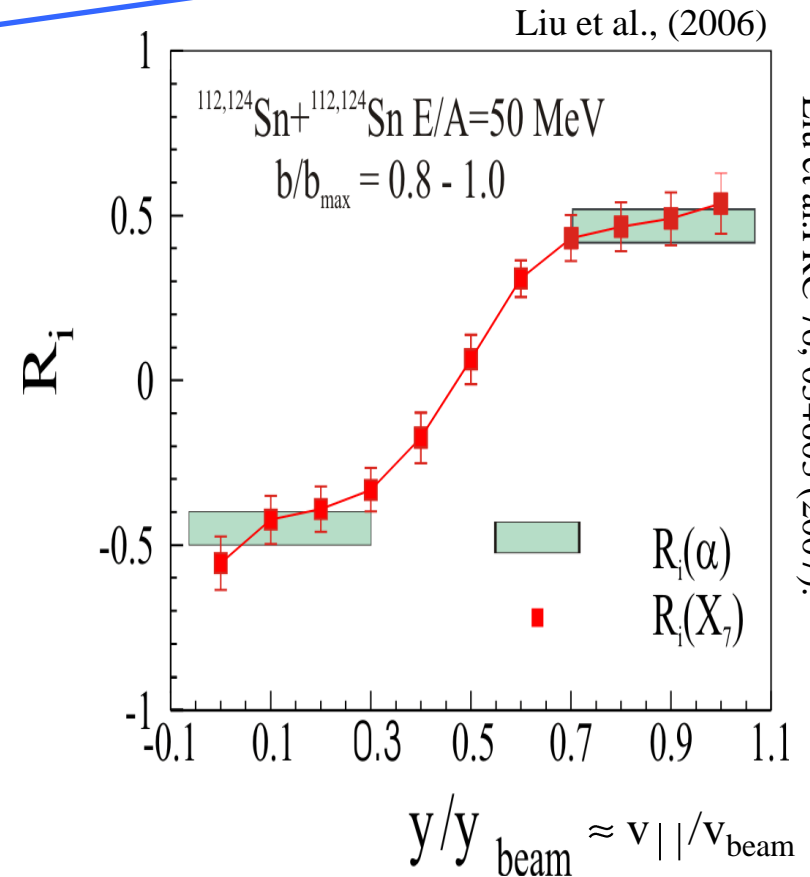

Comparison to QMD calculations

- IQMD calculations were performed for $\gamma_i=0.35-2.0$, $S_{\text{int}}=17.6$ MeV.
- Momentum dependent mean fields with $m_n^*/m_n = m_p^*/m_p = 0.7$ were used.
Symmetry energies: $S(\rho) \approx 12.3 \cdot (\rho/\rho_0)^{2/3} + 17.6 \cdot (\rho/\rho_0)^{\gamma_i}$

- Experiment samples a range of impact parameters
 - $b \approx 5.8-7.2$ fm.
 - larger b , smaller γ_i
 - smaller b , larger γ_i

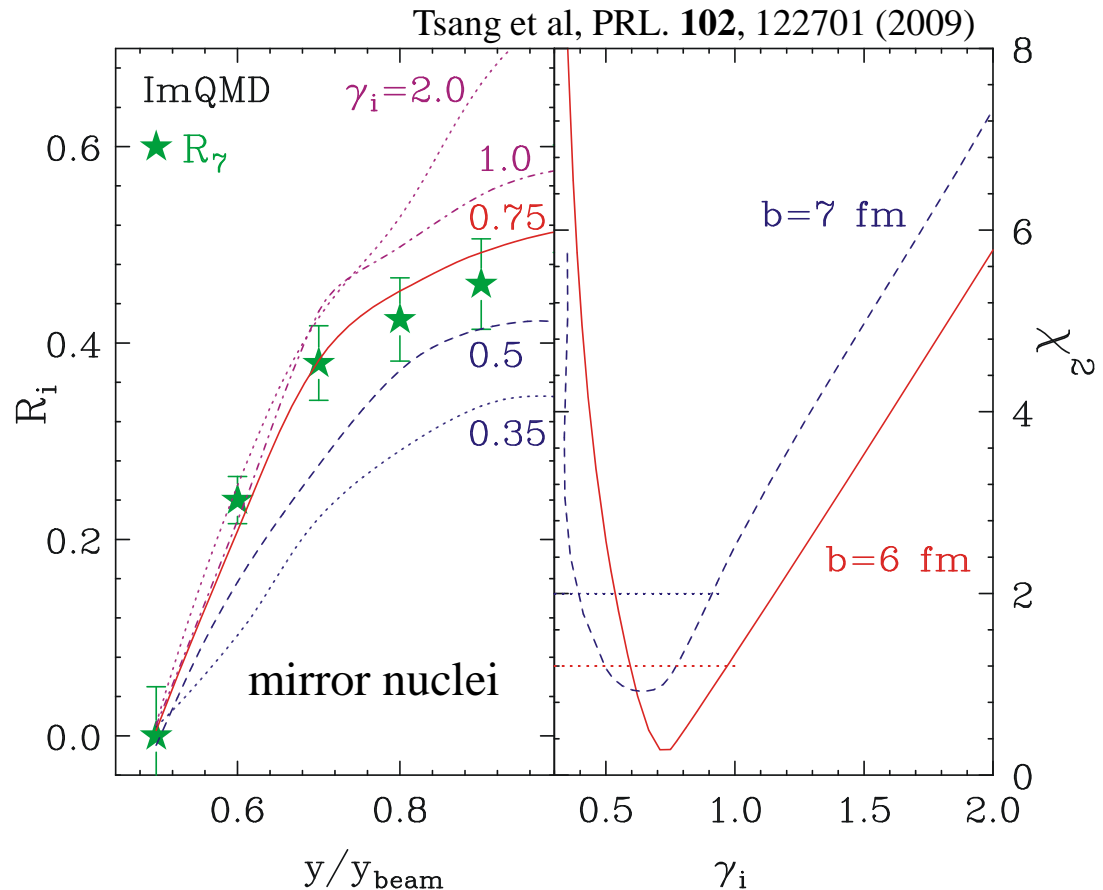

Measurement of n/p spectral ratios: probes the pressure due to asymmetry term at $\rho \leq \rho_0$.

- **Isospin fractionation:** Expulsion of neutrons from bound neutron-rich system by symmetry energy.
- Has been probed by direct measurements of n vs. proton emission rates

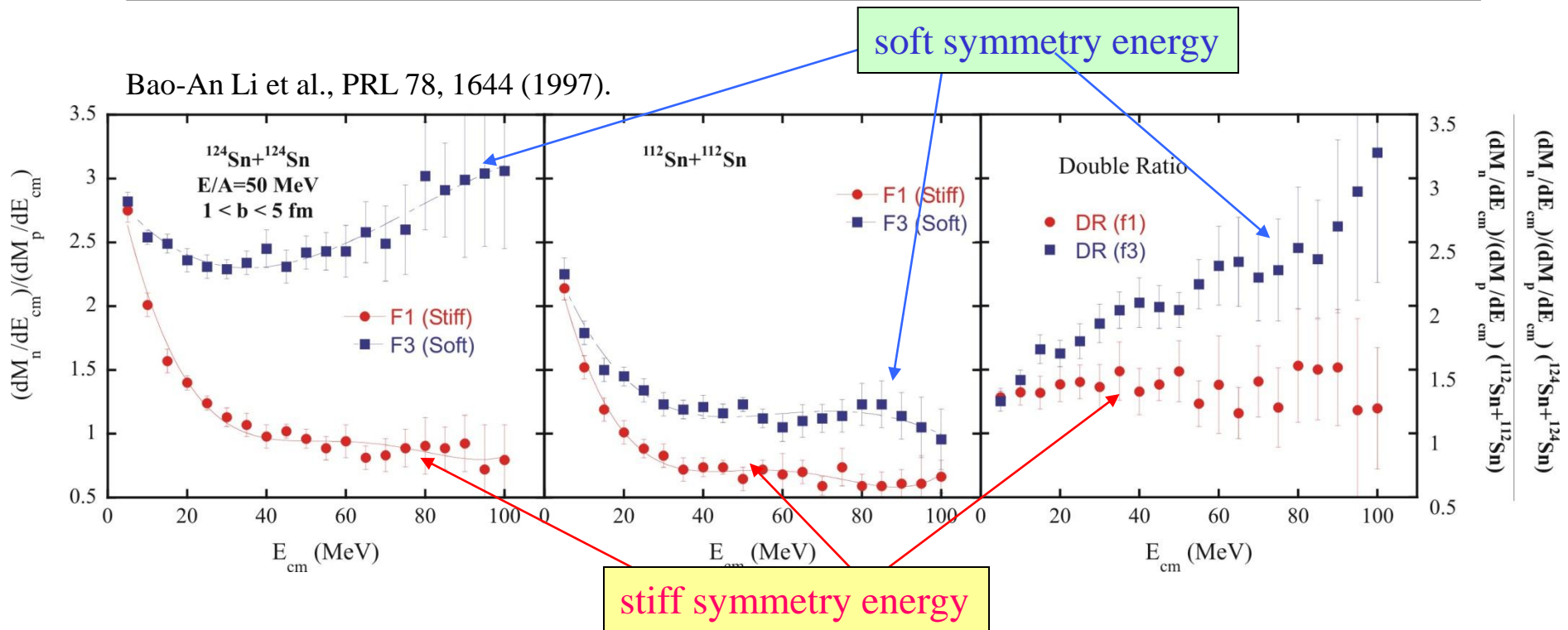

- Double ratio removes the sensitivity to neutron efficiency and energy calibration.

n/p Experiment $^{124}\text{Sn}+^{124}\text{Sn}$; $^{112}\text{Sn}+^{112}\text{Sn}$; E/A=50 MeV

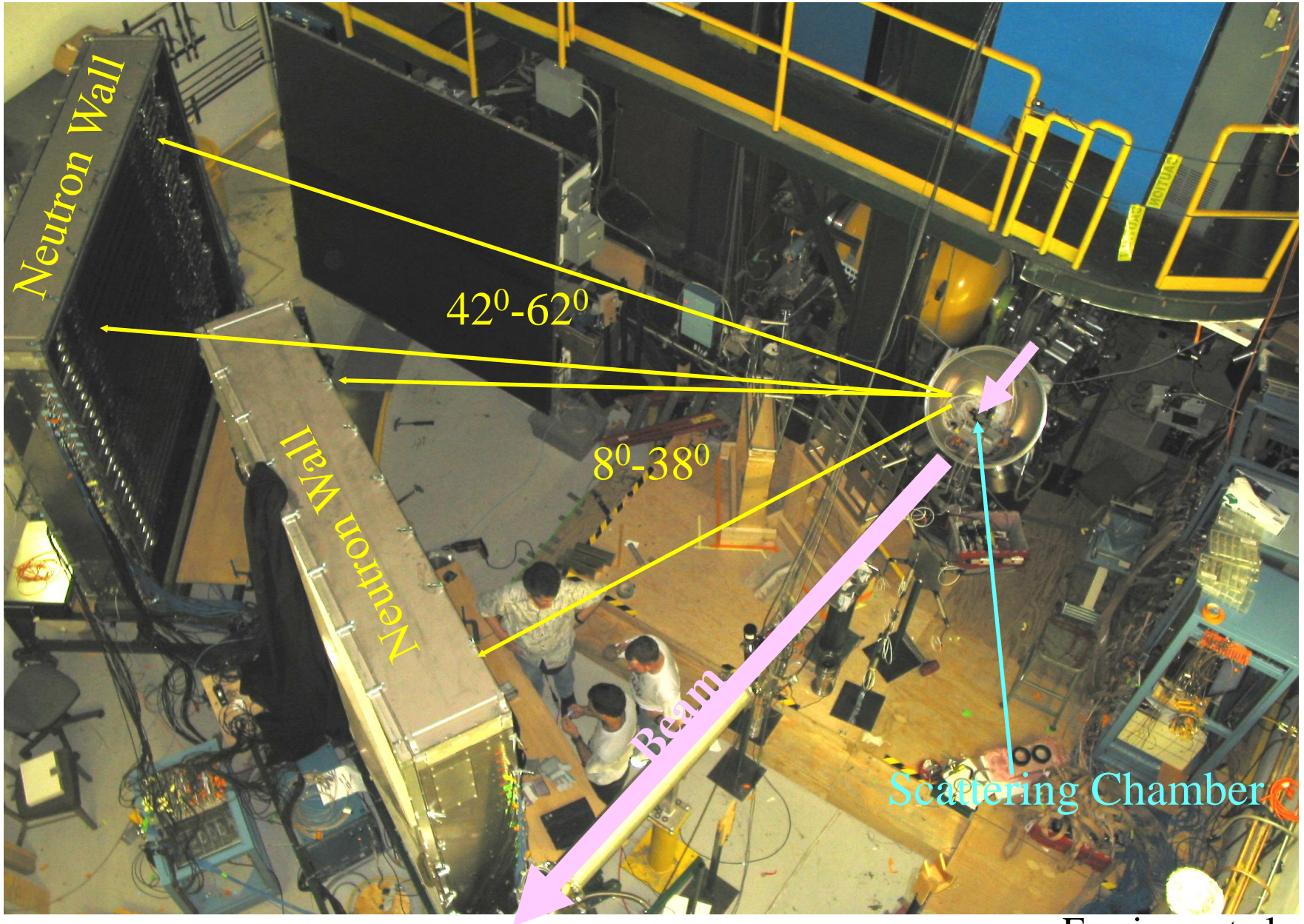

P-detection: Scattering Chamber

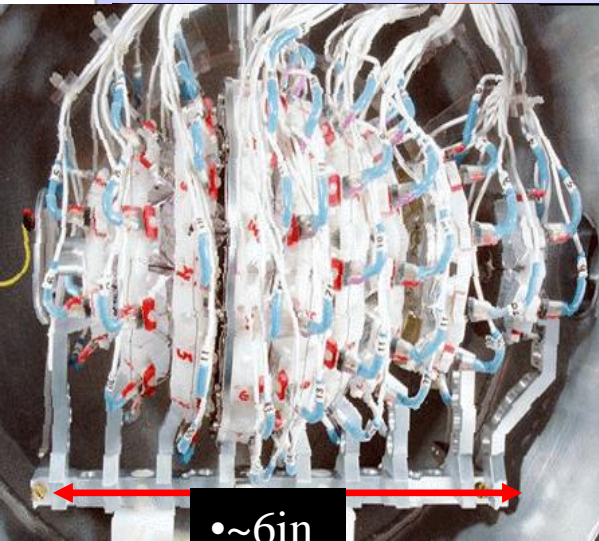

- WU MicroBall
- (b determination)

•n-TOF start detector

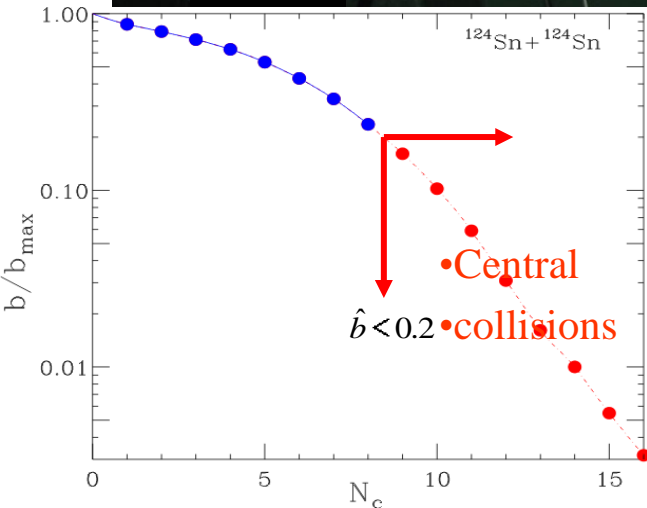

- 3 particle telescopes
- (p, t, ^3He , ...)

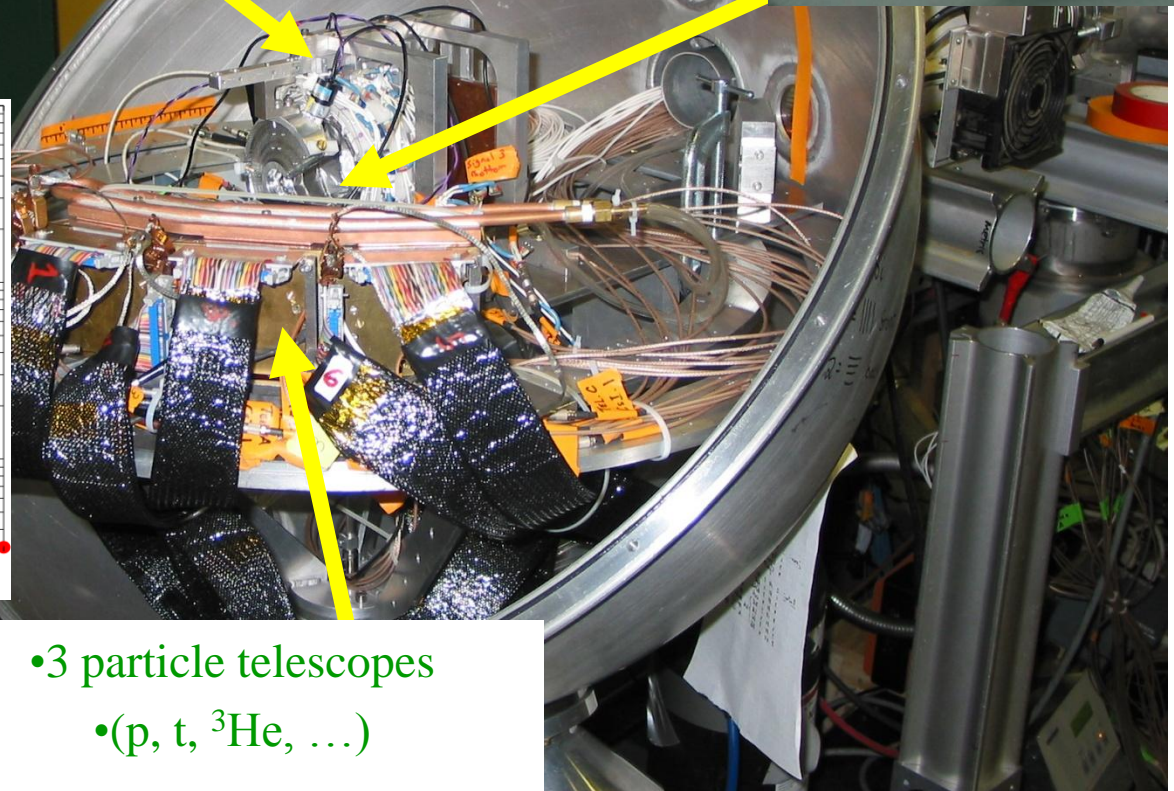
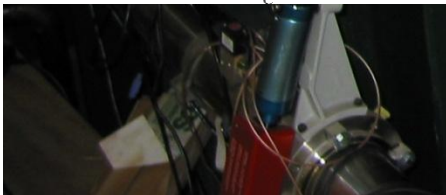

IQMD comparisons to free n/p ratios

Tsang et al, PRL. **102**, 122701 (2009)

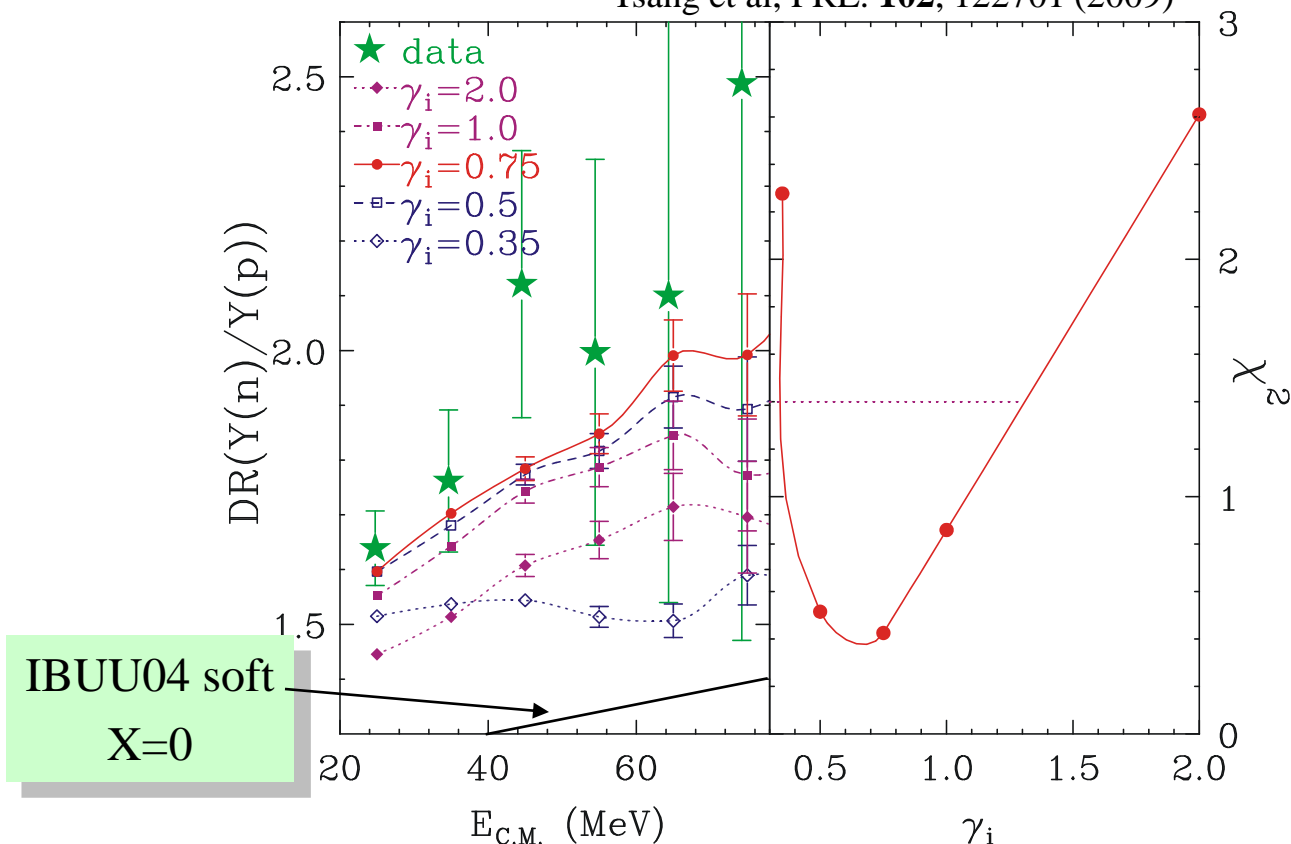

- Calculation includes similar symmetry energy to BUU97, as well as momentum dependent mean fields $m_n^* = m_p^* \approx 0.7m_N$
- Calculations reproduce free and coalescence invariant ratios (not shown), and ratios of mid-rapidity fragment spectra (not shown).
- Results disagree with IBUU04, which assumes $m_n^* > m_p^*$.

Vary S_0 to obtain allowed values for different S_0 and compare to other probes and analyses

Tsang et al., PRL 102, 122701 (2009).

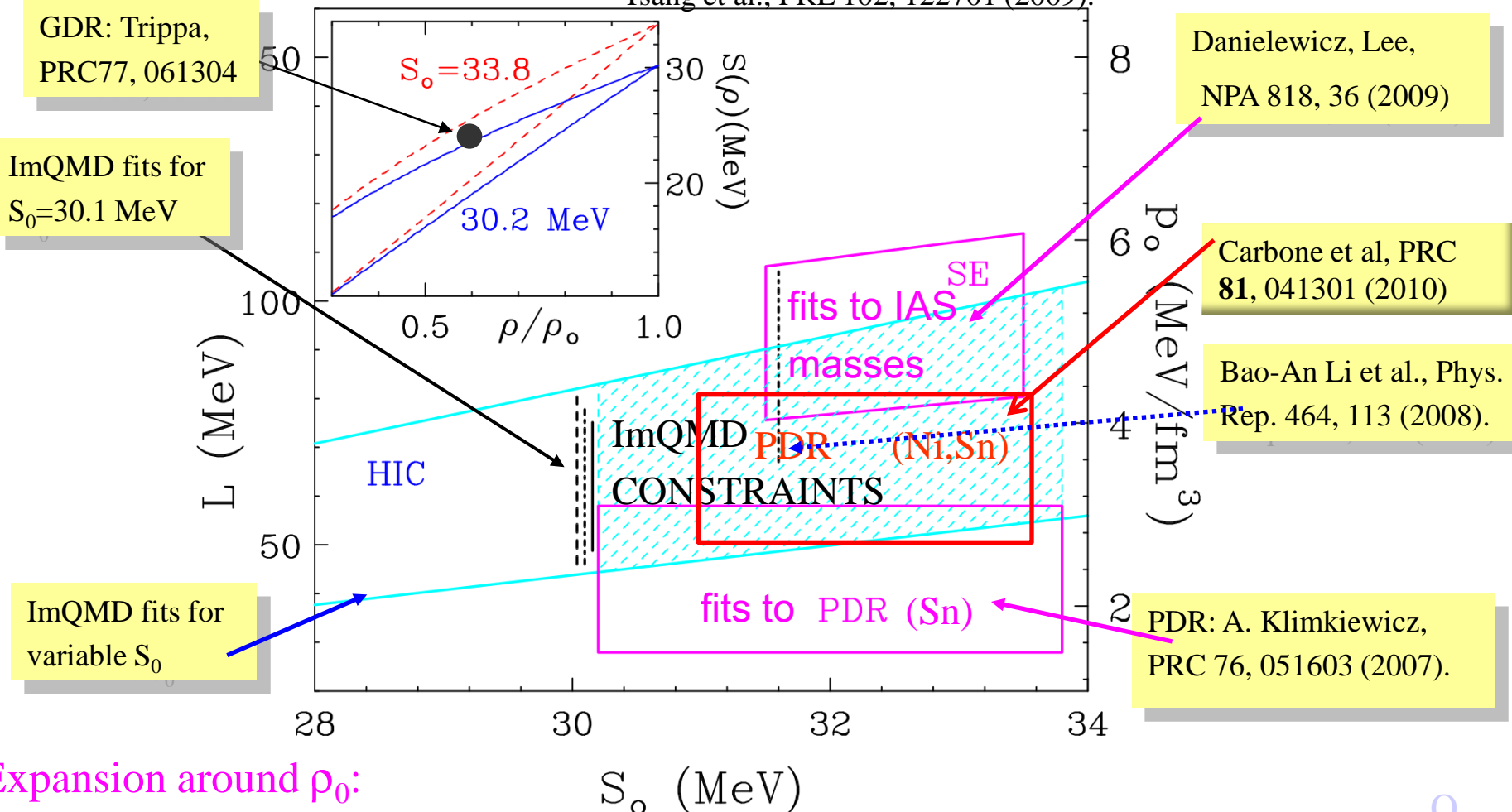

Expansion around ρ_0 :

→ Symmetry slope L & curvature K_{sym}

$$E_{sym} = S_0 + \frac{L}{3} \left(\frac{\rho_B - \rho_0}{\rho_0} \right) + \frac{K_{sym}}{18} \left(\frac{\rho_B - \rho_0}{\rho_0} \right)^2 + \dots$$

→ Symmetry pressure P_{sym}

$$L = 3\rho_0 \left. \frac{\partial E_{sym}}{\partial \rho_B} \right|_{\rho_B = \rho_0} = \frac{3}{\rho_0} P_{sym}$$

New measurements of Sn+Sn collisions at $E/A = 35$ MeV and comparisons of ImQMD calculations

Z. Sun et al., (2009).

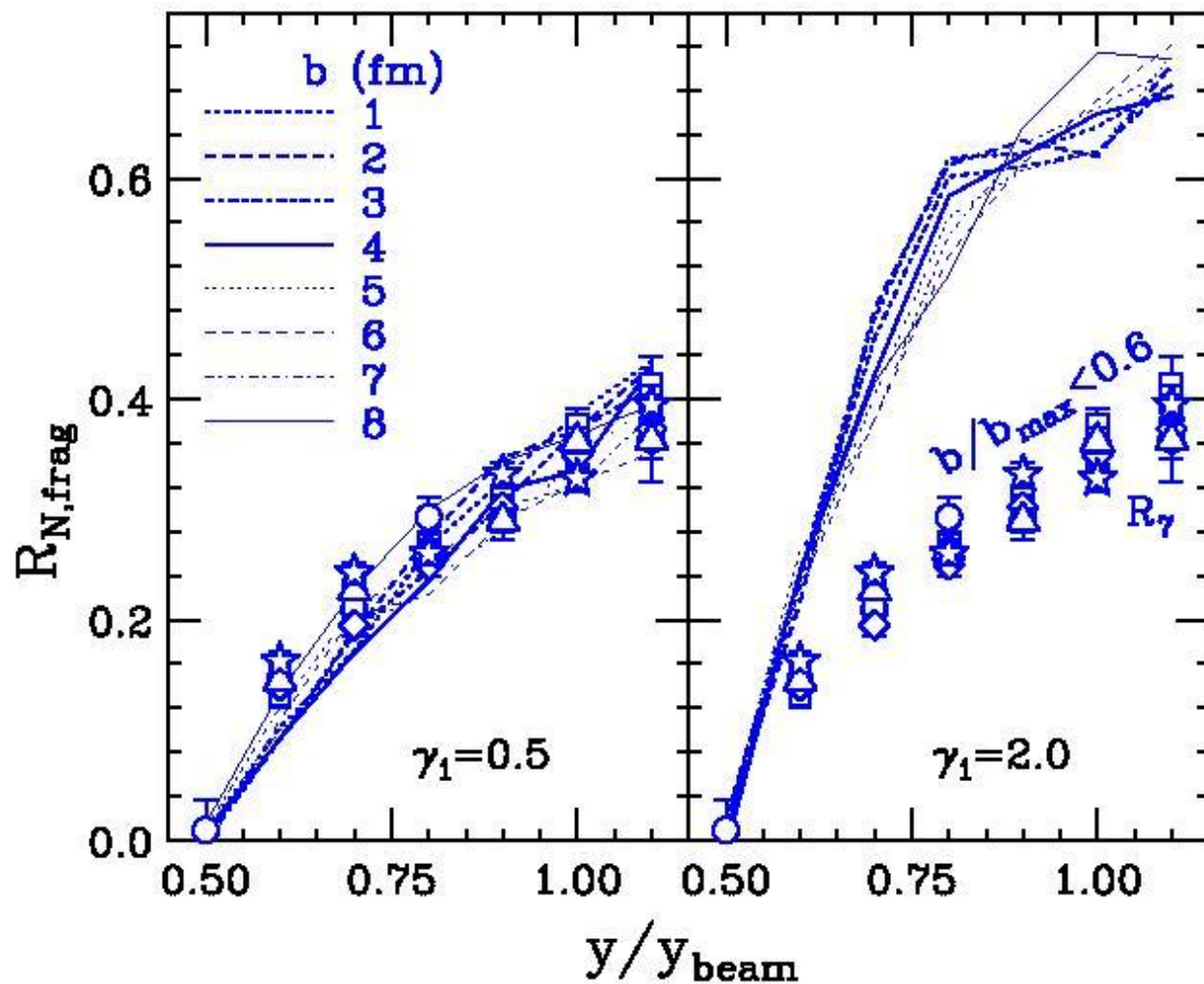

No complete stopping or isospin equilibration in central collisions

Data are in good agreement with $\gamma_1 \sim 0.5$, consistent with $E/A = 50$ MeV data.

Isospin dependence of the effective mass

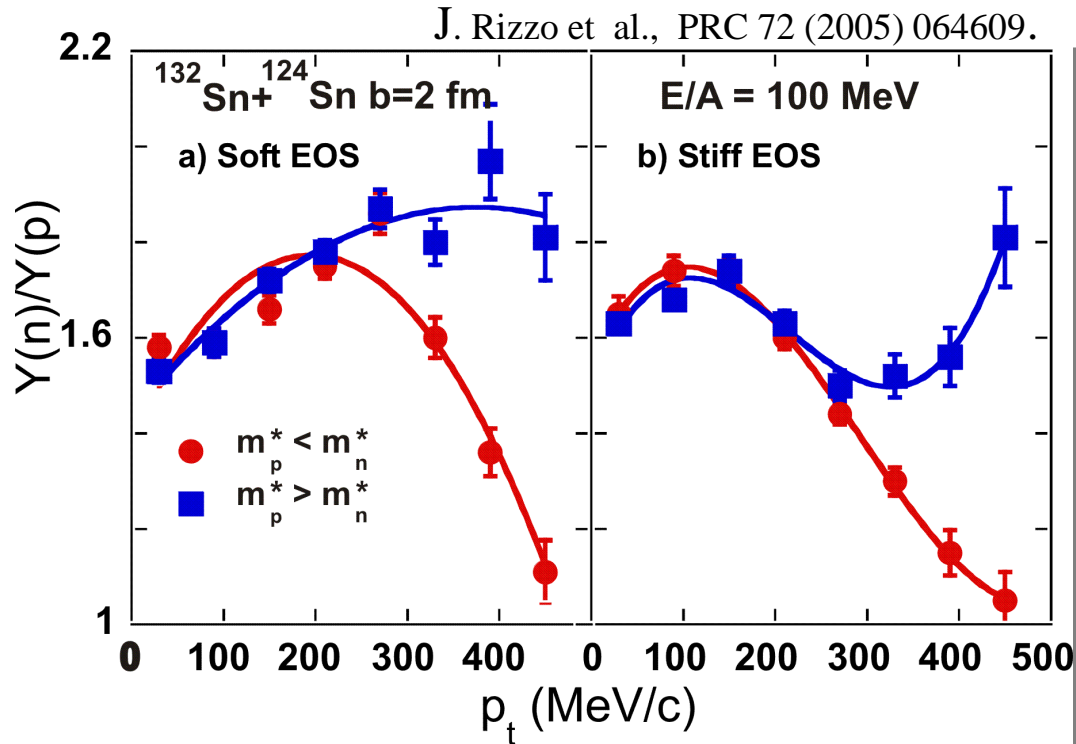

- If the symmetry potential is momentum dependent, it will cause the effective masses of neutrons and protons to differ and cause a change in the ratio of neutron/proton spectra.
- Measurements of $^{124}\text{Sn} + ^{124}\text{Sn}$ and $^{112}\text{Sn} + ^{112}\text{Sn}$ collisions were performed at $E/A=120$ MeV last fall to address this question.

Asymmetry term studies at $\rho \approx 2\rho_0$

(Unique contribution from collisions investigations)

- Densities of $\rho \approx 2\rho_0$ can be achieved at $E/A \approx 400$ MeV.
 - Provides information about neutron star radii, direct Urca cooling in proto-neutron stars, stability and phase transitions of dense neutron star interior.
- $S(\rho)$ influences diffusion of neutrons from dense overlap region at $b=0$.
 - Diffusion is greater in neutron-rich dense region is formed for stiffer $S(\rho)$.
- Experiments are being planned to investigate these phenomena

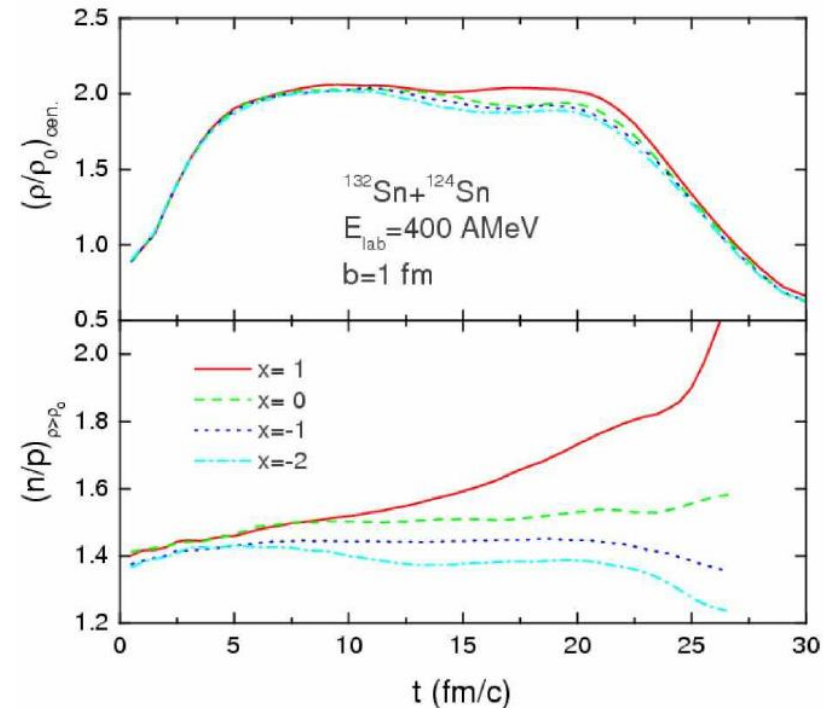
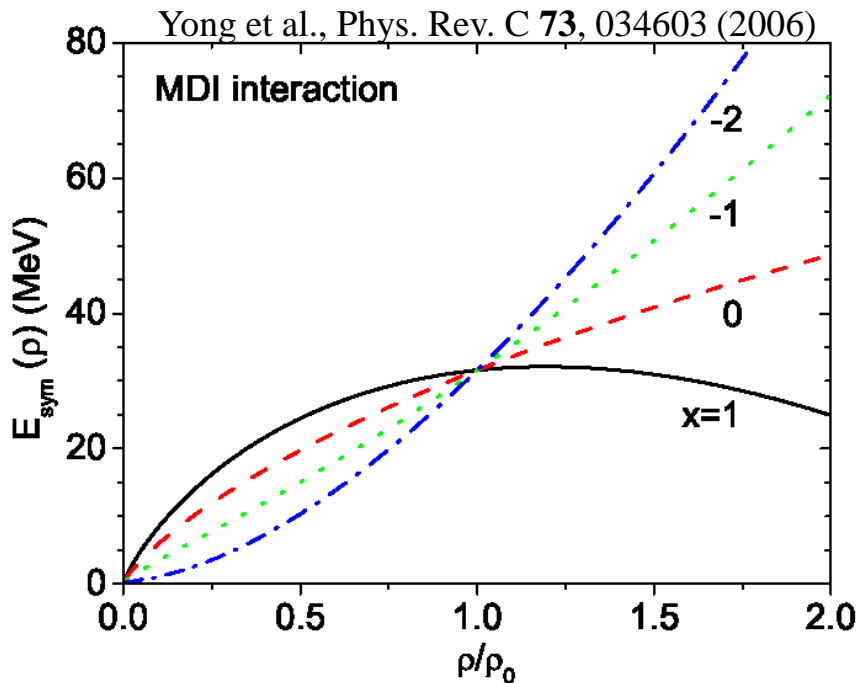

High density probe: pion production

- Larger values for ρ_n / ρ_p at high density for the soft asymmetry term ($x=0$) causes stronger emission of negative pions for the soft asymmetry term ($x=0$) than for the stiff one ($x=-1$).
- π^- / π^+ means $Y(\pi^-) / Y(\pi^+)$
 - In delta resonance model, $Y(\pi^-) / Y(\pi^+) \approx (\rho_n / \rho_p)^2$
 - In equilibrium, $\mu(\pi^+) - \mu(\pi^-) = 2(\mu_p - \mu_n)$
- The density dependence of the asymmetry term changes ratio by about 10% for neutron rich system.

Li et al., Nucl.Phys. A734 (2004) 593.

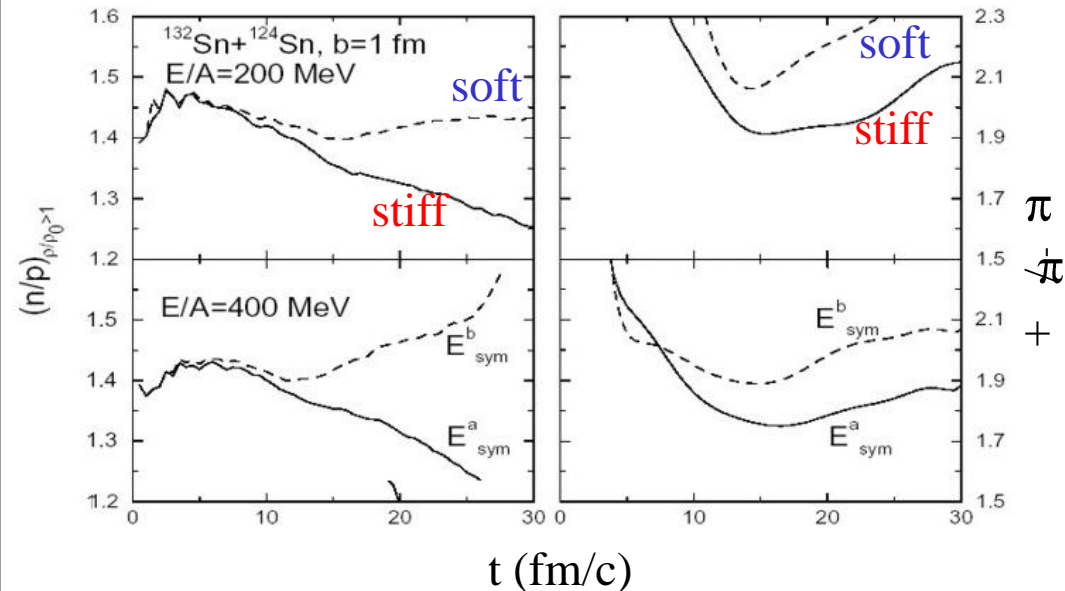

- Investigations are planned with stable or rare isotope beams at the MSU and RIKEN.
 - Sensitivity to $S(\rho)$ occurs primarily near threshold in A+A

Choice of beams for pion ratios

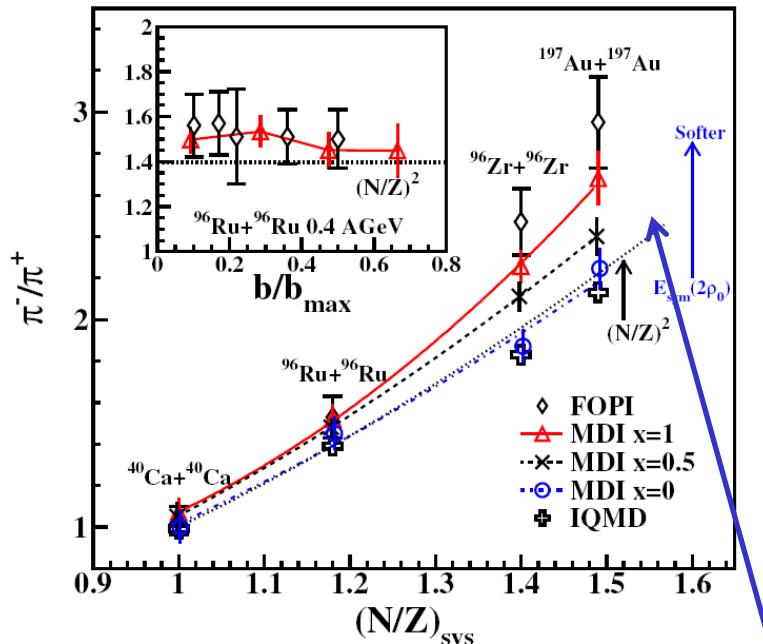

Reisdorf, et al., NPA 781 (2007) 459.
 Xiao, et al., arXiv:0808.0186 (2008)

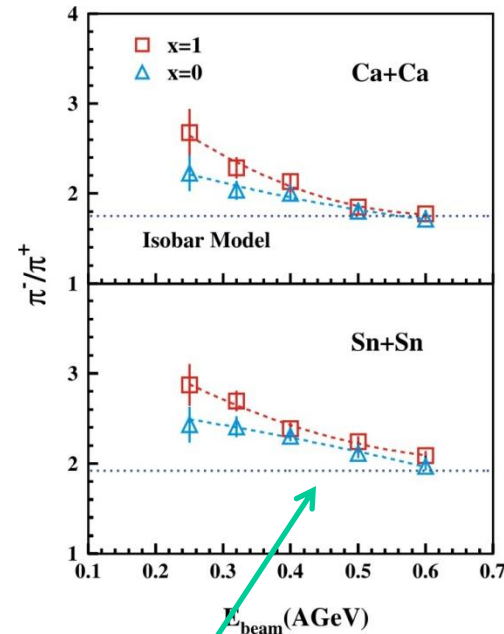

Zhang et al., arXiv:0904.0447v2 (2009)

- Sensitivity to symmetry energy is larger for neutron-rich beams
- Sensitivity increases with decreasing incident energy.
- Data have been measured for Au+Au collisions.
- It would be interesting to measure with rare isotope beams such as ^{132}Sn and ^{108}Sn .
 - Interesting comparison because the Coulomb interaction is the same for both to first order. Coulomb also strongly influences the pion ratios.

Au+Au data suggest very weak density dependence at $\rho > 3\rho_0$

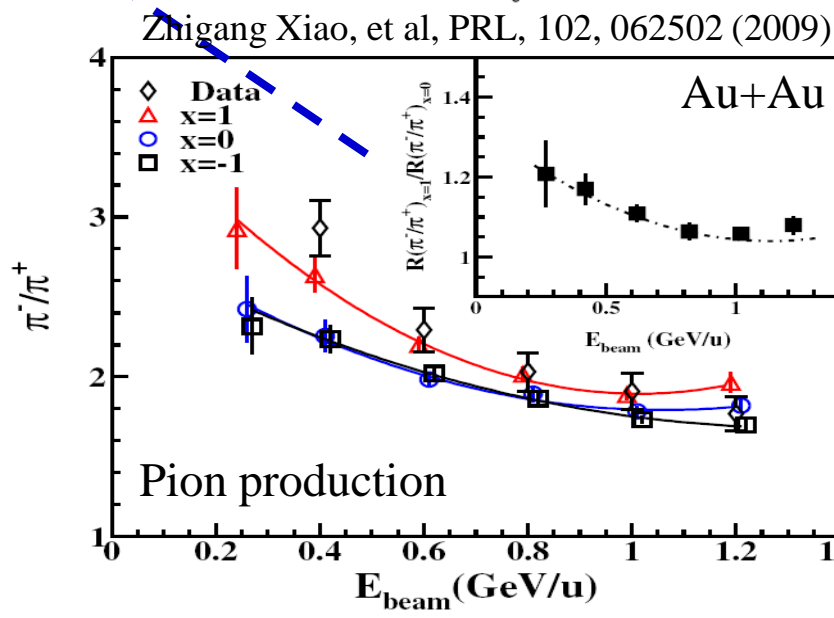
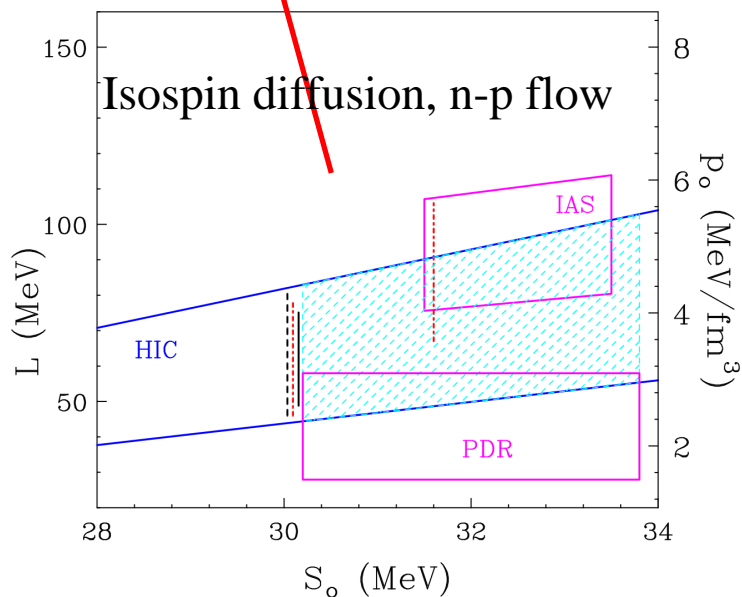
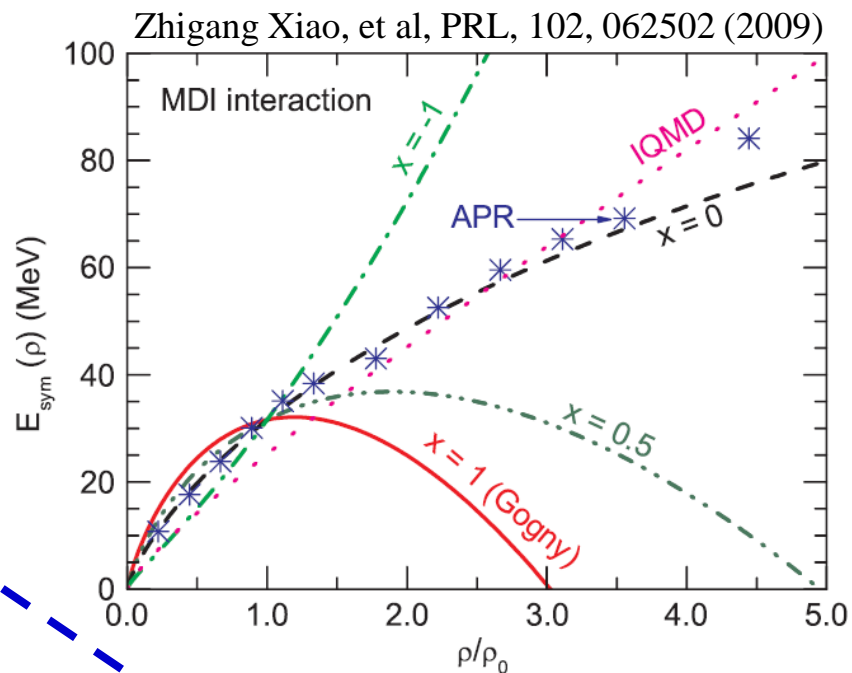
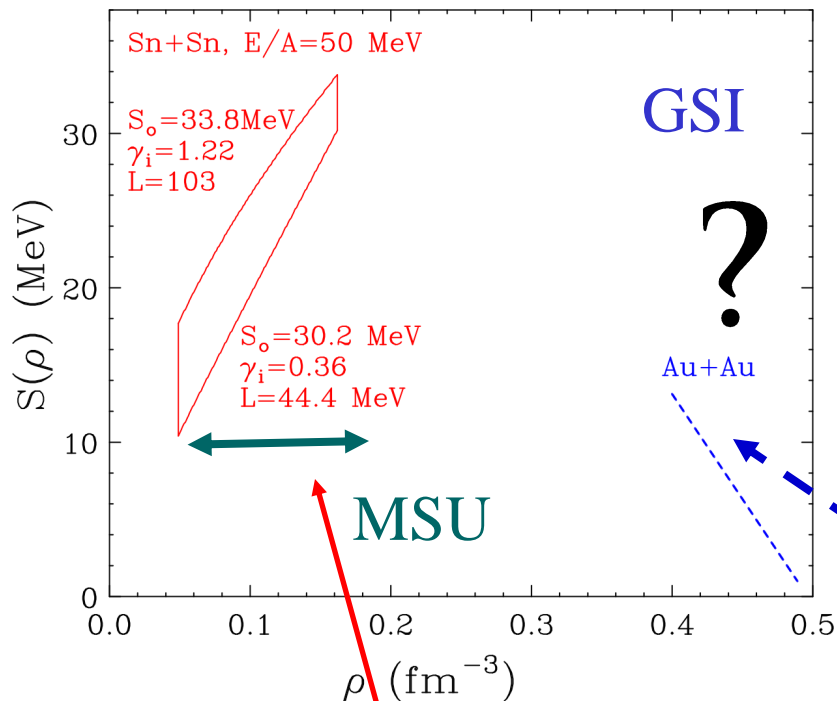

More quantitative comparisons are needed

- Au data involved considerable corrections for the pion acceptances.
- Pion spectra, ratios of pion spectra and pion flows ratios can provide more quantitative comparisons, and tests of theory.
- However the Coulomb interaction strongly influences such observables.
- Here, $\pi^- / \pi^+ = Y(\pi^-)/Y(\pi^+)$.

π^- / π^+

Yong et al., Phys. Rev. C **73**, 034603 (2006)

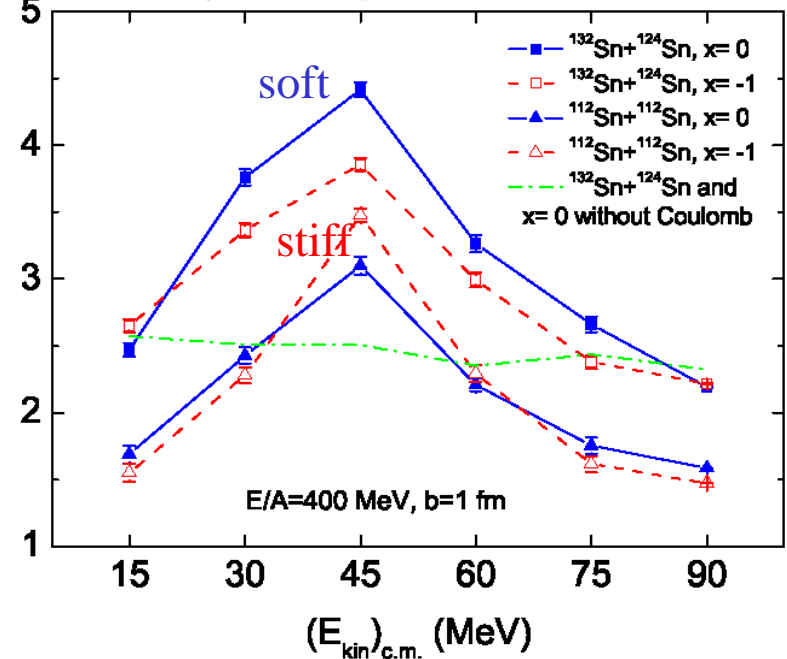

- Such experiments are planned at RIKEN and MSU

Double ratio: pion production

- Yong et al., proposed measuring pion double ratios involving two systems with the same charge but different neutron number
 - Can remove the sensitivity to Coulomb and retain sensitivity to symmetry energy
- Example: $^{132}\text{Sn}+^{124}\text{Sn}$ and $^{112}\text{Sn}+^{112}\text{Sn}$ systems.

$$R^{\pi^-/\pi^+} \left(\frac{^{132}\text{Sn}+^{124}\text{Sn}}{^{112}\text{Sn}+^{112}\text{Sn}} \right) = \frac{\left[\frac{Y(\pi^-)_{^{132}\text{Sn}+^{124}\text{Sn}}}{Y(\pi^+)_{^{132}\text{Sn}+^{124}\text{Sn}}} \right]}{\left[\frac{Y(\pi^-)_{^{112}\text{Sn}+^{112}\text{Sn}}}{Y(\pi^+)_{^{112}\text{Sn}+^{112}\text{Sn}}} \right]}$$

- Largely removes sensitivity to difference between π^- and π^+ acceptances.

Yong et al., Phys. Rev. C **73**, 034603 (2006)

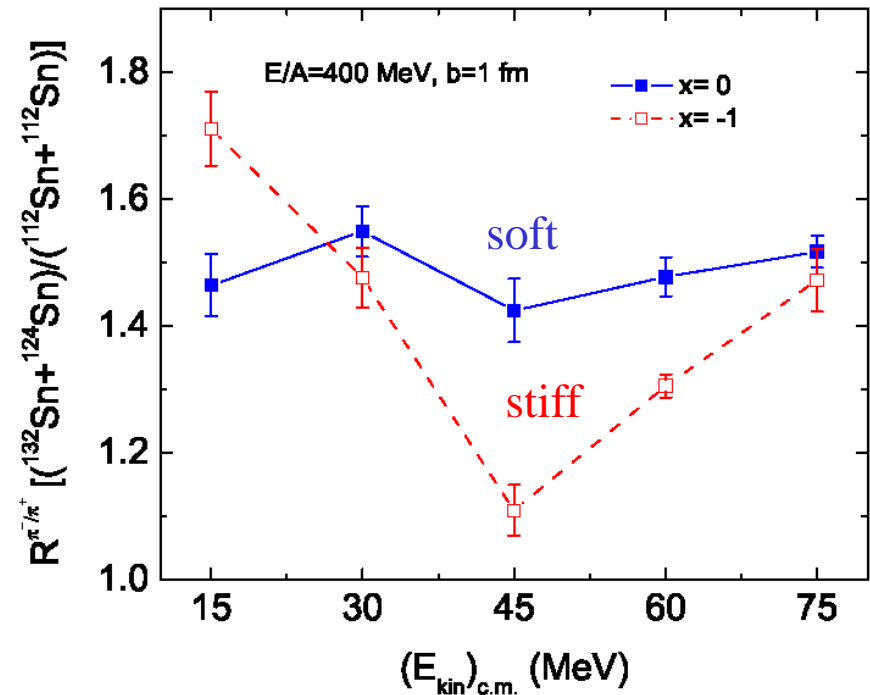

- Such experiments are planned at RIKEN and MSU

Comparisons of neutron and proton observables :

- Most models predict the differences between neutron and proton flows and t and ^3He flows to be sensitive to the symmetry energy and the n and p effective mass difference.
- In this prediction, the ratio of neutron over proton spectra out of the reaction plane displays a significant sensitivity the symmetry energy.

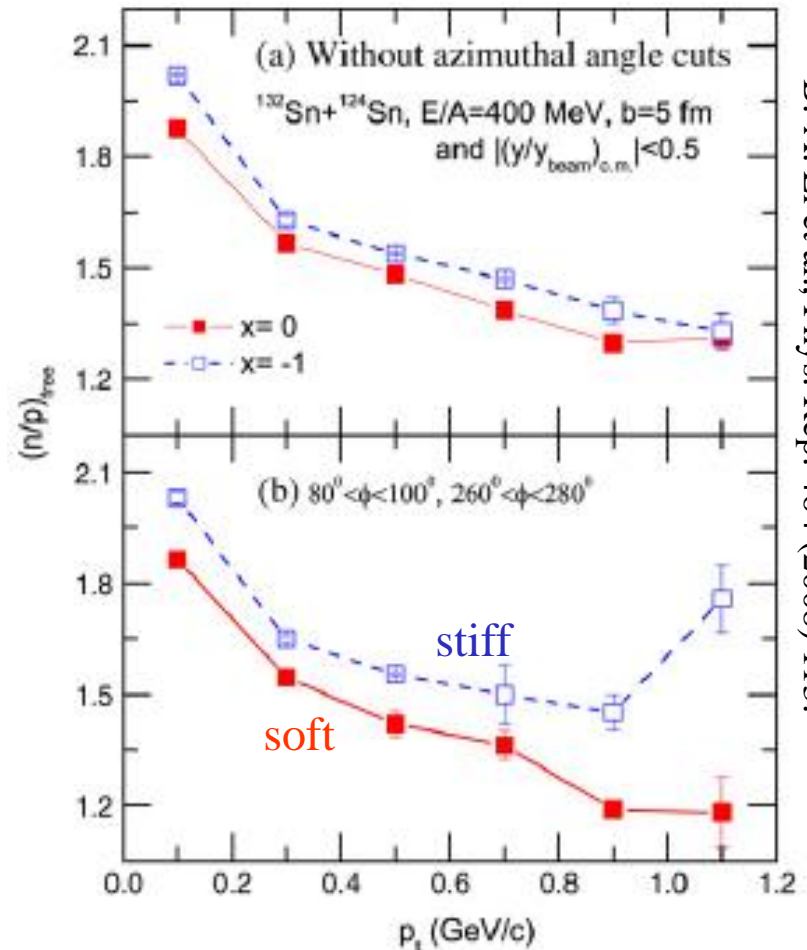

B.-A. Li et al., Phys. Rep. 464 (2008) 113.

- Such measurements will be performed next year at GSI:
 - P. Russotto et al.

n-p differential transverse flow

- Transverse directed flow is usually obtained by plotting the mean transverse momentum $\langle p^x \rangle$ vs. the rapidity y .
- The neutron-proton differential flow is defined here to be:

$$F_{n-p}^x = \frac{1}{N} \left\langle \sum_i^{N(y)} (v_i p_i^x) \right\rangle$$

$$w_i = 1 (-1); \text{neut. (prot.)}$$

- Sensitivity to acceptance effects might be minimized by constructing the difference:

$$D_{n-p}^x = F_{n-p}^x \left({}^{132}\text{Sn} + {}^{124}\text{Sn} \right) - F_{n-p}^x \left({}^{12}\text{Sn} + {}^{112}\text{Sn} \right)$$

Li et al., arXiv:nucl-th/0504069 (2005)

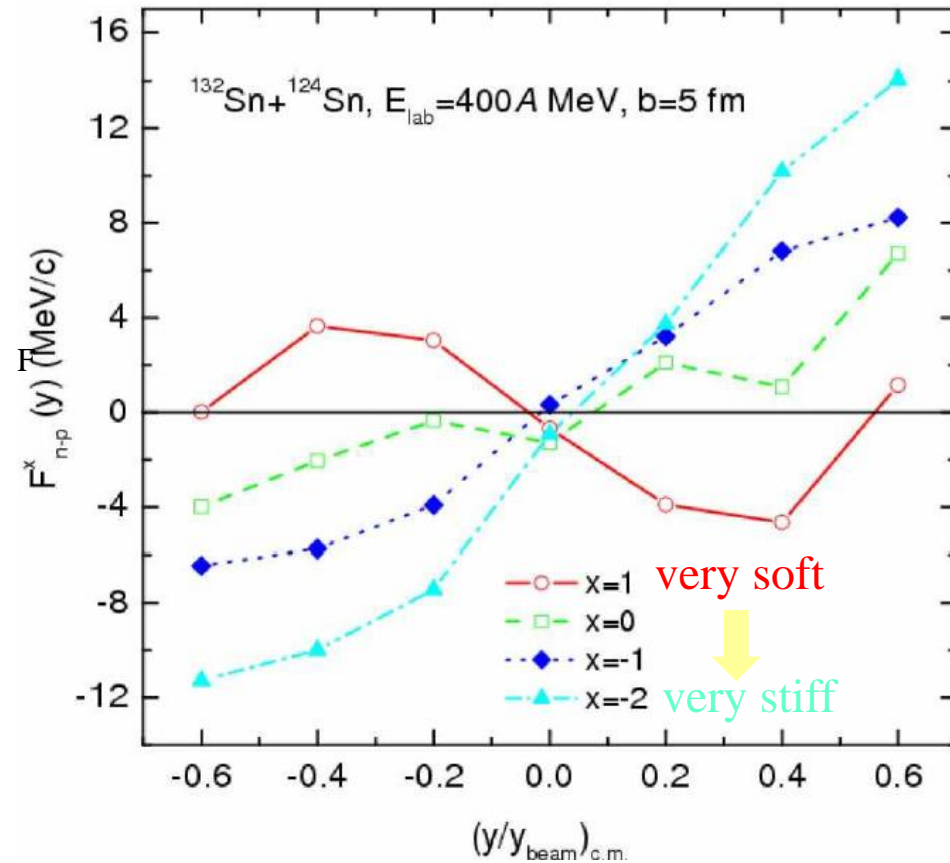

Device: SAMURAI TPC

T. Murakami^a, Jiro Murata^b, Kazuo Ieki^b, Hiroyoshi Sakurai^c, Shunji Nishimura^c, Atsushi Taketani^c, Yoichi Nakai^c, Betty Tsang^d, William Lynch^d, Abigail Bickley^d, Gary Westfall^d, Michael A. Famiano^e, Sherry Yennello^g, Roy Lemmon^h, Abdou Chbihiⁱ, John Franklandⁱ, Jean-Pierre Wieleczkoⁱ, Giuseppe Verde^j, Angelo Paganoⁱ, Paulo Russottoⁱ, Z.Y. Sun^k, Wolfgang Trautmann^l

^aKyoto University, ^bRikkyo University, ^cRIKEN, Japan, ^dNSCL Michigan State University, ^eWestern Michigan University, ^gTexas A&M University, USA, ^hDaresbury Laboratory, ⁱGANIL, France, UK, ^jLNS-INFN, Italy, ^kIMP, Lanzhou, China, ^lGSI, Germany

- The SAMURAI TPC would be used to constrain the density dependence of the symmetry energy through measurements of:
 - Pion production
 - Flow, including neutron flow measurements with the nebula array.
- The TPC also can serve as an active target both in the magnet or as a standalone device.
 - Giant resonances.
 - Asymmetry dependence of fission barriers, extrapolation to r-process.

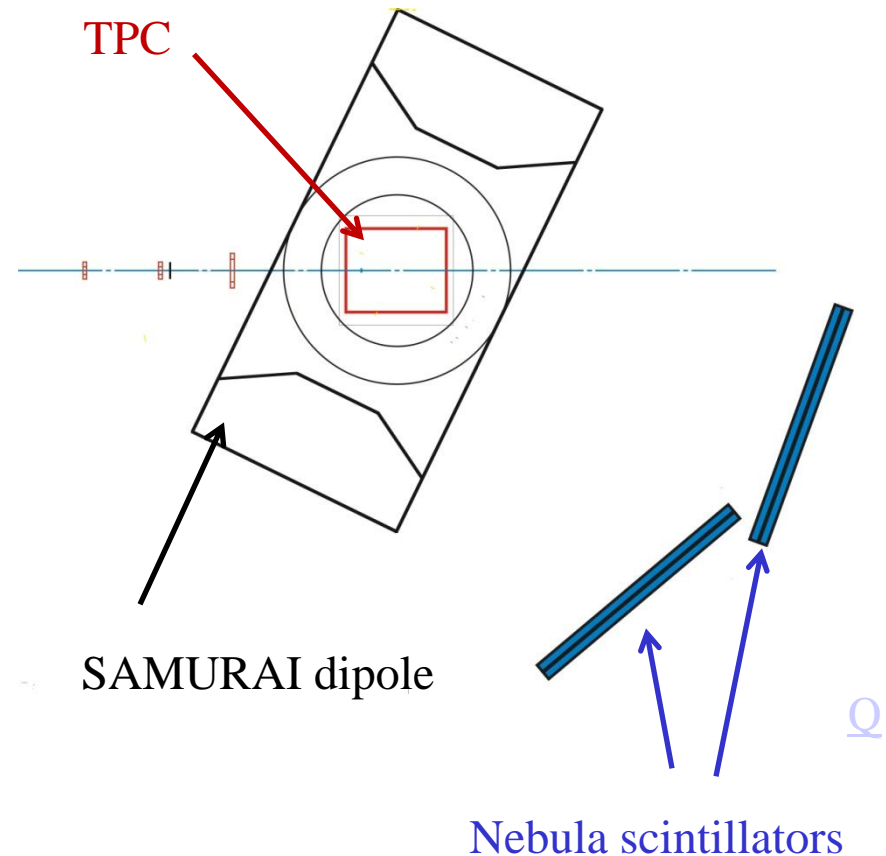

Devices: SAMURAI TPC at RIKEN

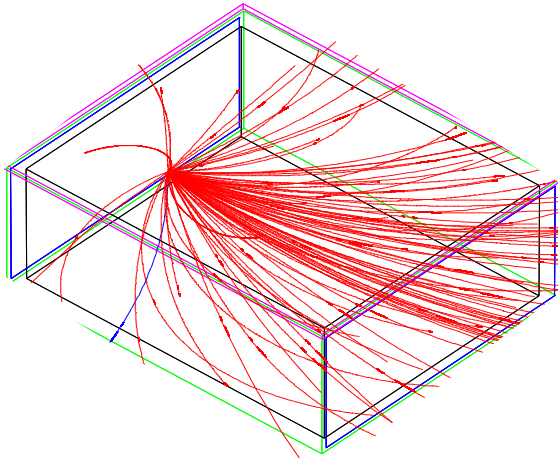

GEANT simulation

$^{132}\text{Sn} + ^{124}\text{Sn}$ collisions at $E/A=300$ MeV

- Good efficiency for pion track reconstruction is essential.
- Initial design is based upon EOS TPC, whose properties are well documented.

SAMURAI TPC parameters	
Pad plane area	1.3m x 0.9 m
Number of pads	111664 (108 x 108)
Pad size	12 mm x 8 mm
Drift distance	55 cm
Pressure	1 atmosphere
dE/dx range	Z=1-3 (Star El.), 1-8 (Get El.)
Two track resolution	2.5 cm
Multiplicity limit	200 (large systems absolute pion eff.)

MSU:Active Target Time Projection Chamber

D Bazin, M. Famiano, U. Garg, M. Heffner, R. Kanungo, I. Y. Lee,
W.Lynch, W. Mittig, L. Phair, D Suzuki, G. Westfall

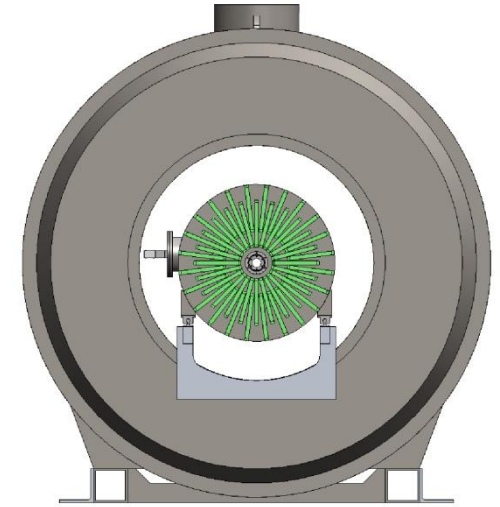
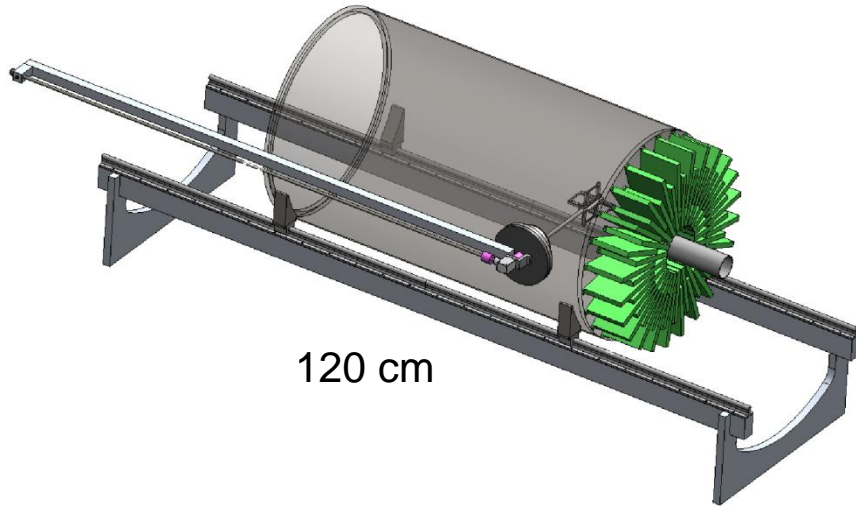

- Two alternate modes of operation
 - Fixed Target Mode with target wheel inside chamber:
 - 4π tracking of charged particles allows full event characterization
 - Scientific Program » **Constrain Symmetry Energy at $\rho > \rho_0$**
 - Active Target Mode:
 - Chamber gas acts as both detector and thick target (H_2 , D_2 , 3He , Ne, etc.) while retaining high resolution and efficiency
 - Scientific Program » **Transfer & Resonance measurements, Astrophysically relevant cross sections, Fusion, Fission Barriers, Giant Resonances**

Summary

- The EOS describes the macroscopic response of nuclear matter and finite nuclei.

$$\varepsilon(\rho,0,\delta) = \varepsilon(\rho,0,0) + \delta^2 \cdot S(\rho) ; \delta = (\rho_n - \rho_p) / (\rho_n + \rho_p) = (N-Z)/A$$

- Isoscalar giant resonances , kaon production and high energy flow measurements have placed constraints on the symmetric matter EOS, but the EOS at large isospin asymmetries is not well constrained.
- The behavior at large isospin asymmetries is described by the symmetry energy.
 - It influences many nuclear physics quantities:
 - binding energies,
 - neutron skin thicknesses, isovector giant resonances,
 - isospin diffusion,
 - proton vs. neutron emission and π^- vs. π^+ emission
 - neutron-proton correlations.
 - Measurements of these quantities can constrain the symmetry energy.
- Constraints on the symmetry energy and on the EOS will be improved by planned experiments. Some of the best ideas probably have not been discovered.

Influence of production mechanism on isoscaling parameters

Primary: Before decay of excited fragments, Final: after decay of excited fragments

- Statistical theory:
 - Final isoscaling parameters are often similar to those of the primary distribution
 - Both depend linearly on δ
- $\Rightarrow R(\alpha)=R(\delta)$

- Dynamical theories:
 - Final isoscaling parameters are often smaller than those of primary distribution
 - Both depend linearly on δ
- $\Rightarrow R(\alpha)=R(\delta)$
 - Doesn't matter which one is correct.

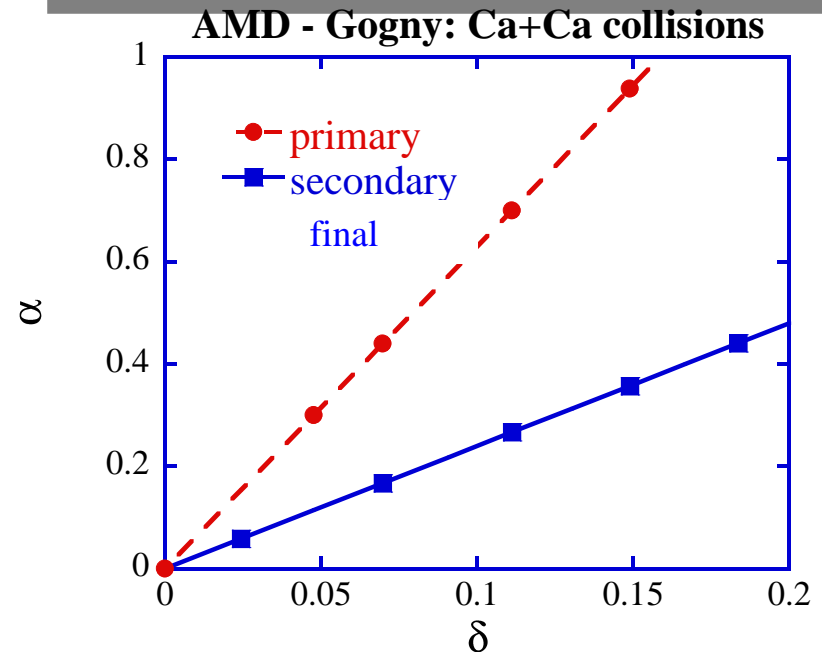
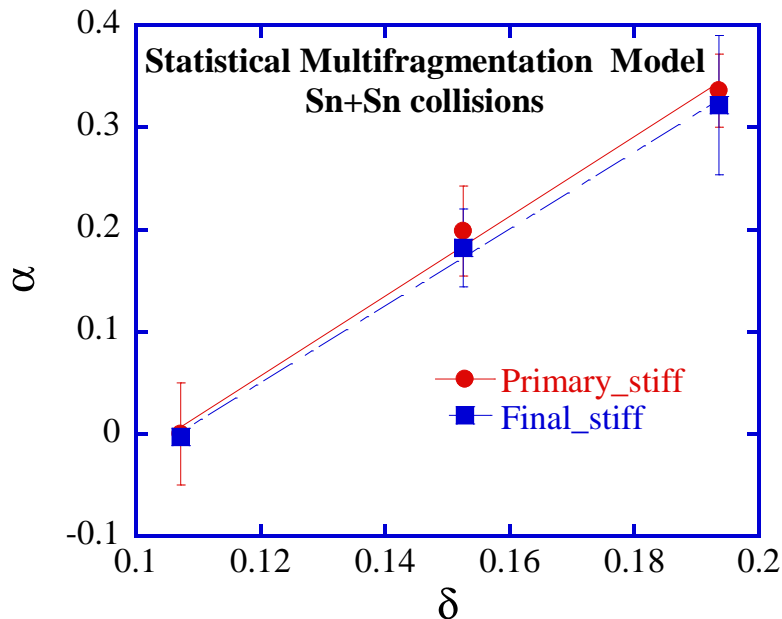

Test of linearity using central collisions

- Data analyzed in well-mixed region at $70^\circ \leq \theta_{\text{cm}} \leq 110^\circ$.

- Linearity is demonstrated for α , β and $\ln(Y(^7\text{Li})/Y(^7\text{Be})) \propto \alpha - \beta$

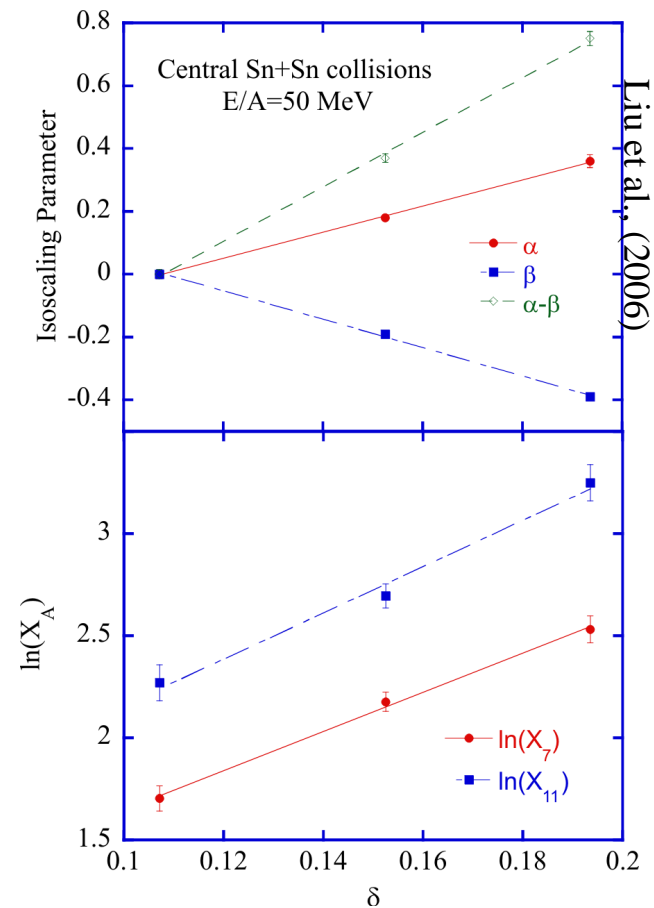
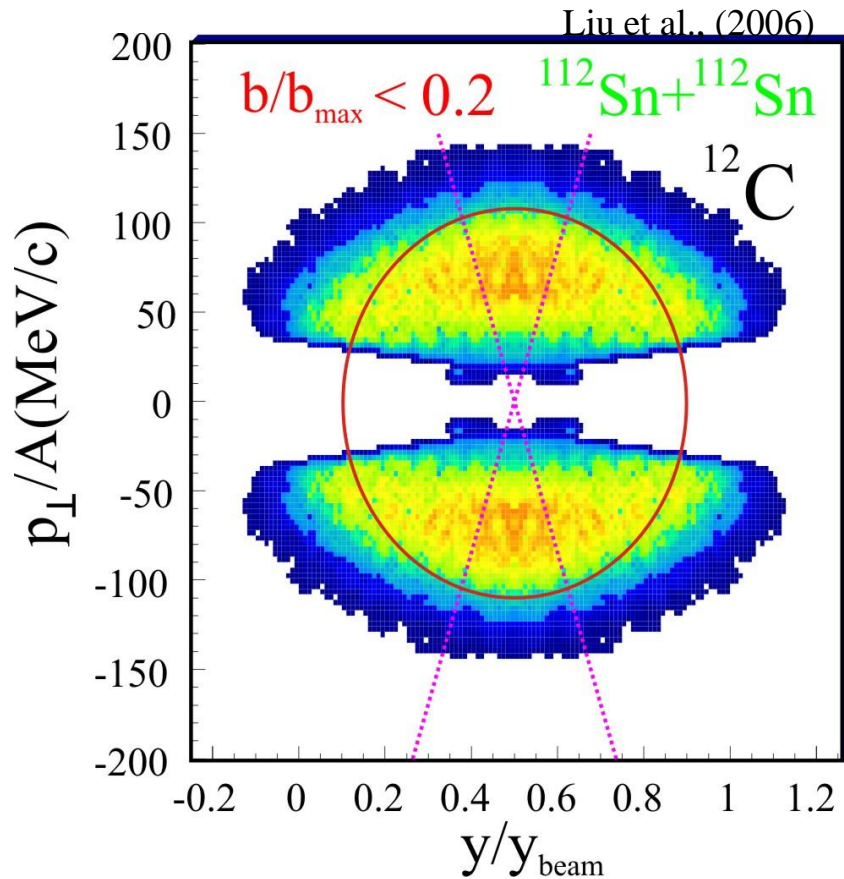

Linearity of α and β in fragmentation models

- Calculations using ISMM display a linear dependence α and β on δ

- Calculations using AMD display a linear dependence α and β on δ for both primary and secondary fragments.

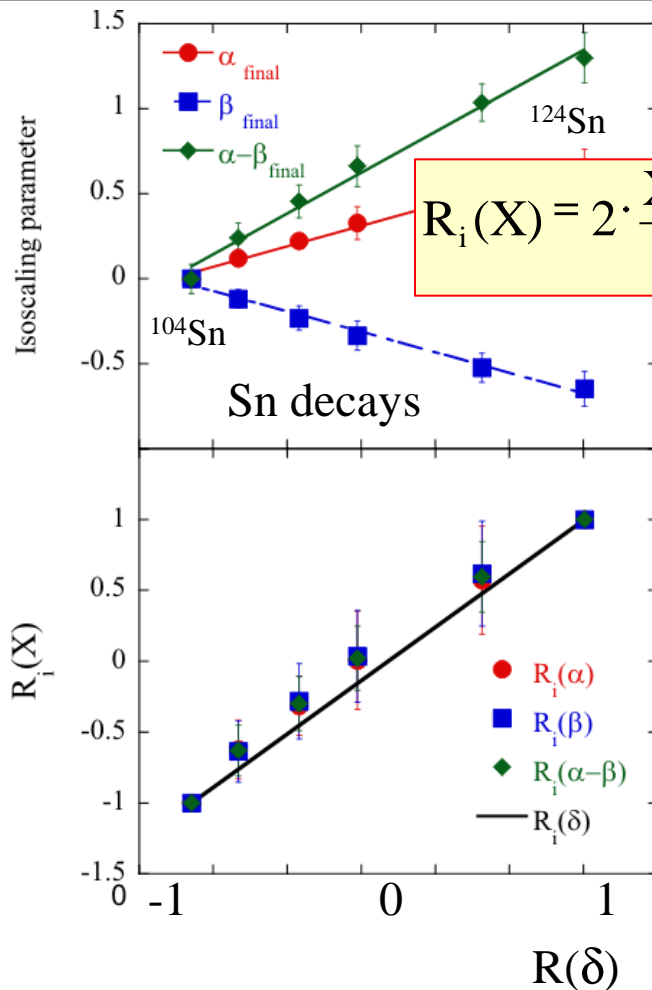

et al., 2002

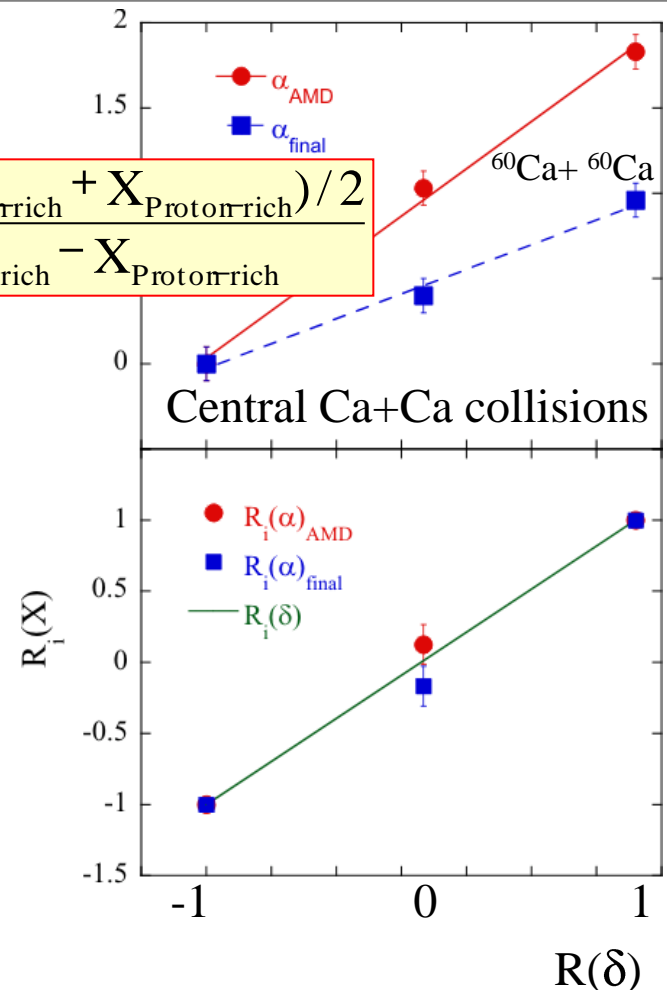

Ono et al., PRC 2005

R

Summary of last lecture

- by various techniques. Skyrme parameterizations are a relatively easy and flexible
 - $\epsilon(\rho,0,\delta) = \epsilon(\rho,0,0) + \delta^2 \cdot S(\rho)$; $\delta = (\rho_n - \rho_p) / (\rho_n + \rho_p) = (N-Z)/A$ The EOS describes the macroscopic response of nuclear matter and finite nuclei. EOS are not well constrained.
- The behavior at large isospin asymmetries is described by the symmetry energy.
 - The symmetry energy has a profound influence on neutron star properties:
 - It can be calculated for the maximum stellar radii, maximum masses, cooling of proto-neutron stars, phases in the stellar interior, etc.
 - Nuclear masses, the differences between neutron and proton matter radii, giant monopole and pigmy dipole resonances can provide information about the symmetry energy

The ImQMD model provides a consistent interpretation of the np ratios and two isospin diffusion measurements

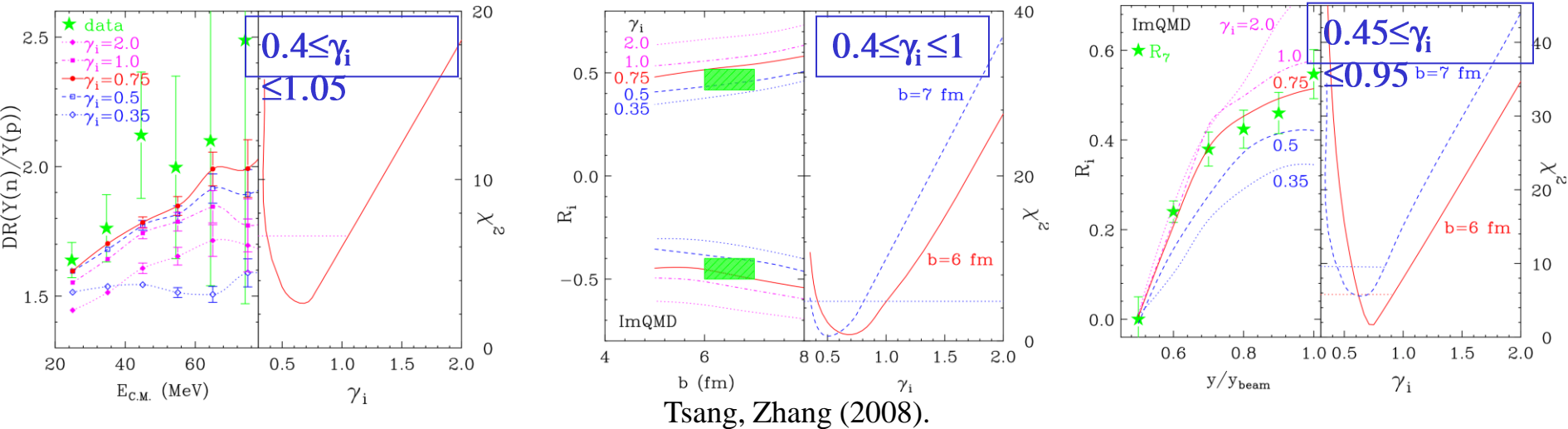

- Consistent χ^2 analyses of these three observables within the ImQMD models provides (note: $S(\rho_0)=30.1$ MeV)

$$S \approx 12.5 \left(\frac{\rho}{\rho_0} \right)^{2/3} + 17.6 \left(\frac{\rho}{\rho_0} \right)^{\gamma_i}; \text{ with } 0.4 \leq \gamma_i \leq 1.0$$

- IBUU04 analysis of isospin diffusion provides: (note: $S(\rho_0)=32$ MeV)

$$S \approx 32 \left(\frac{\rho}{\rho_0} \right)^{\gamma} \text{ with } 0.7 \leq \gamma \leq 1.05$$

Such analyses depend on thickness of the atmosphere.

- In the Eddington limit, the luminosity is given by the stellar mass.
- Luminosity and spectral temperature are combined to get the stellar radius.
- The range of values reflect estimated observational & theoretical uncertainties

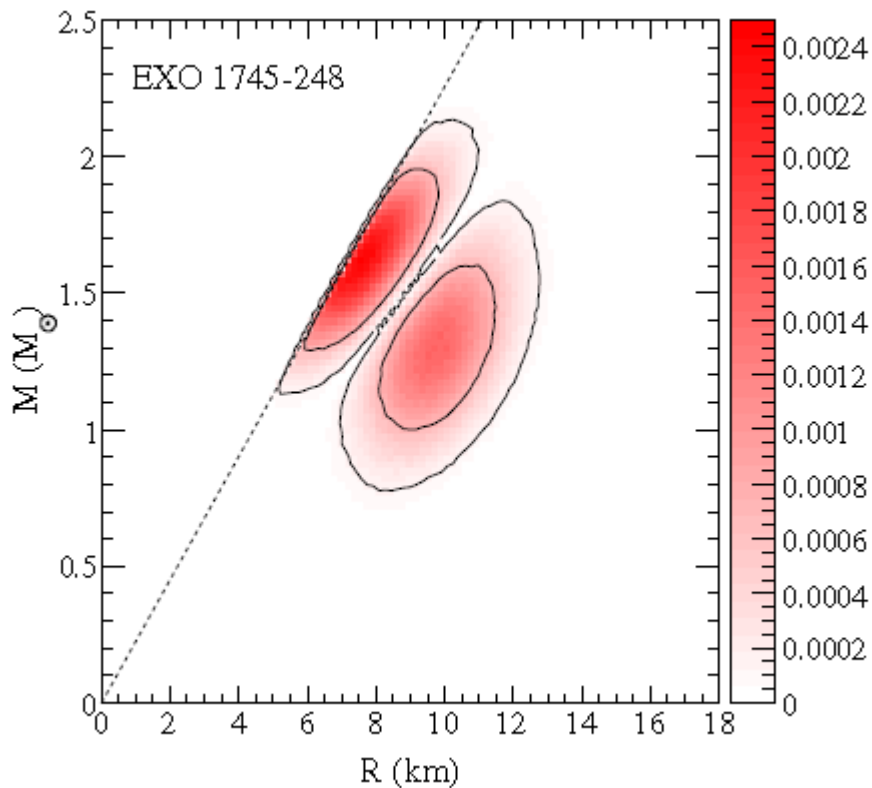

- “Thin atmosphere” $R_{ps} \approx R$

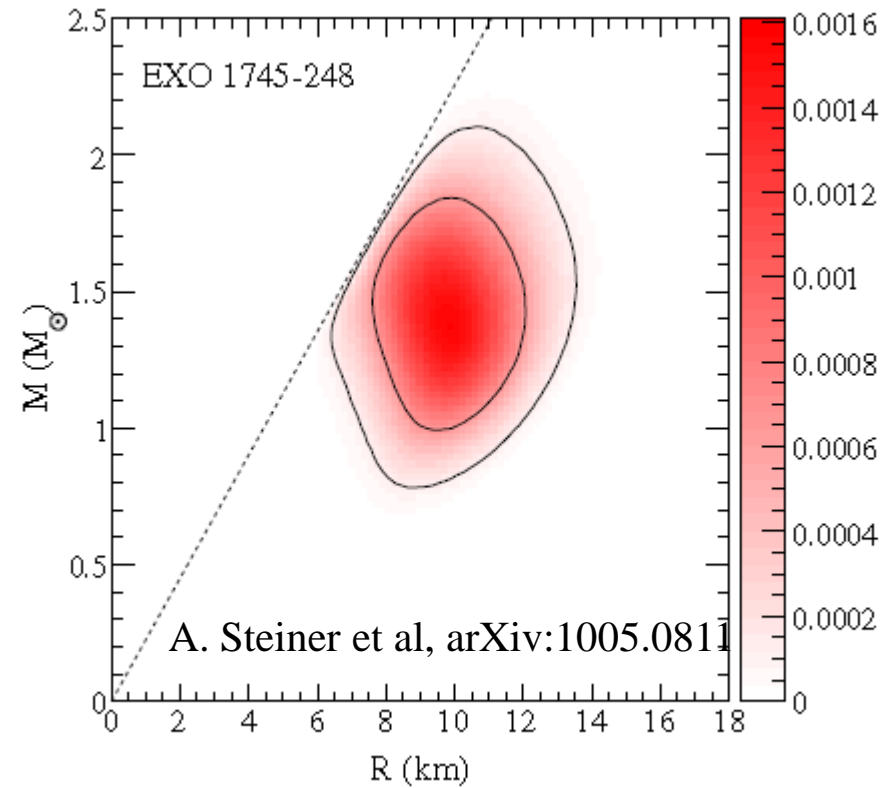

- “Thick atmosphere” $R_{ps} \gg R$

Constraints from Bayesian analysis

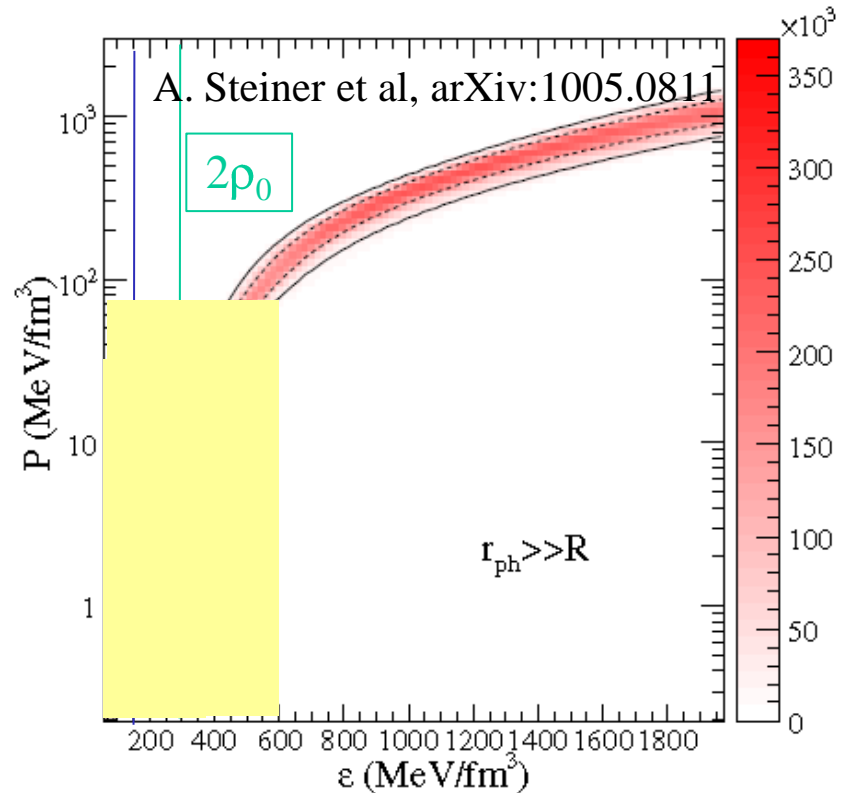
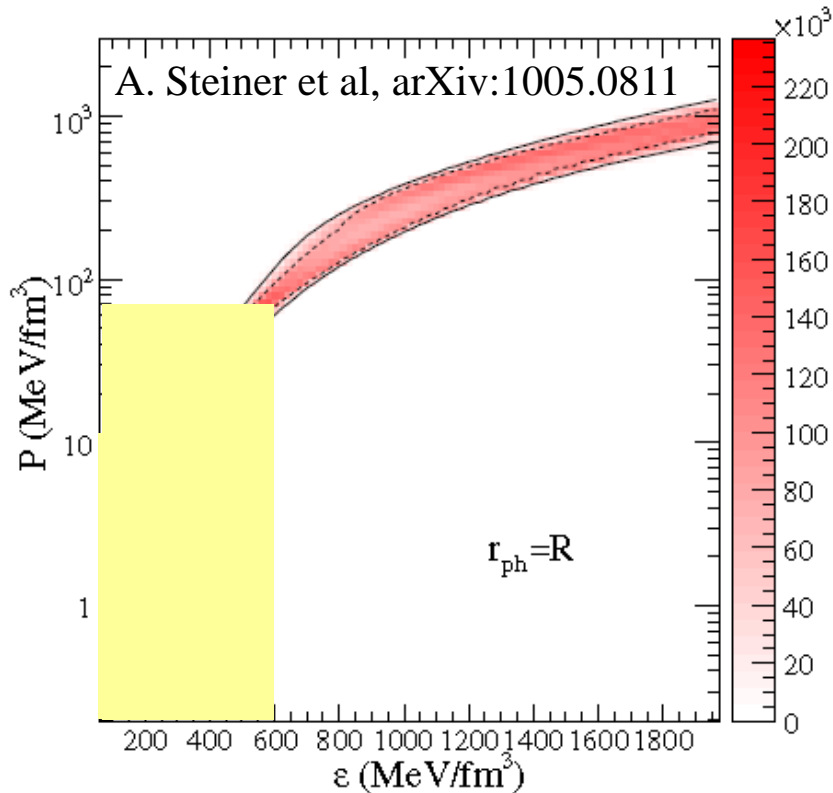

O

- The derived constraints are tight, but depend strongly on X-ray burst model.
- Integral constraint on EoS: Need independent constraints at different densities.
 - Can be provided by laboratory measurements.

Experimental Areas

- A full suite of experimental equipment will be available for fast, stopped and reaccelerated beams

- New equipment

- Stopped beam area (LASERS)
- ISLA Recoil Separator
- Solenoid spectrometer
- Active Target TPC

